

## GNS-10012Axx-Bxx (SINGLE DIGIT LED DISPLAY)

### GNS-10012 Series

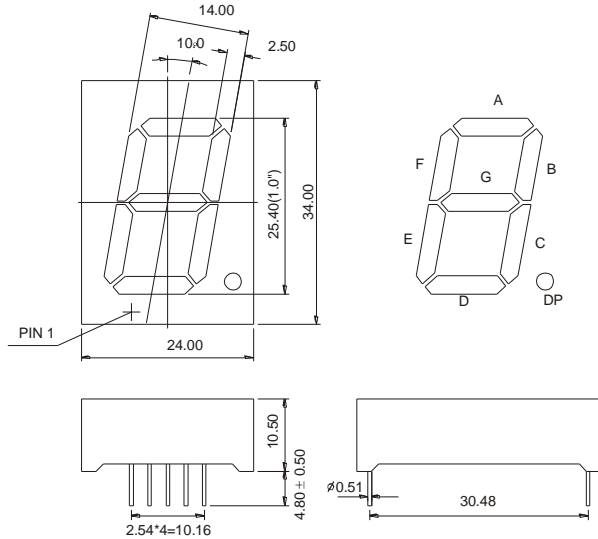

### GNS-10012AEG

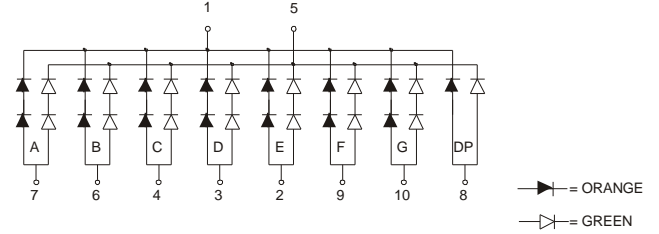

### GNS-10012BEG

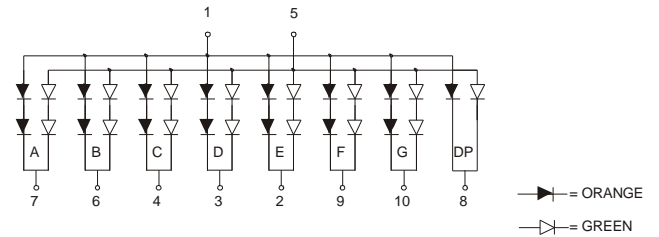

### Features:

\*1.0 INCH HIGH CHARACTER.

\*EXCELLENT CHARACTER APPEARANCE.

\*COMMON CATHODE OR COMMON ANODE.

\*I.C. COMPATIBLE

\*LOW POWER CONSUMPTION.

Part Number	EMITTED COLOR		Common Cathode or Common Anode	Peak Wavelength (nm)	Vf (v) Typ	If (mA)	Intensity Per Segment (mcd)	
							Min.	Typ.
GNS-10012ASG	GaAlAs	Super Red	Common Cathode	660	1.8	20	20	26
	Gap	Green		565	2.1	20	16	22
GNS-10012AEG	GaAsP	Hi.effi Red		635	2.0	20	18	24
	Gap	Green		565	2.1	20	16	22
GNS-10012BSG	GaAlAs	Super Red	Common Anode	660	1.8	20	20	26
	Gap	Green		565	2.1	20	16	22
GNS-10012BEG	GaAsP	Hi.effi Red		635	2.0	20	18	24
	Gap	Green		565	2.1	20	16	22