



**ProLight PM2B-1LxE
1W Power LED
Technical Datasheet
Version: 2.9**



Features

- High flux per LED
- Various colors
- Good color uniformity
- Industry best moisture sensitivity level - JEDEC Level 1
- Lead free reflow soldering
- RoHS compliant
- More energy efficient than incandescent and most halogen lamps
- Low Voltage DC operated
- Instant light (less than 100ns)
- No UV
- Superior ESD protection

Typical Applications

- Reading lights (car, bus, aircraft)
- Portable (flashlight, bicycle)
- Uplighters/Downlighters
- Decorative/Entertainment
- Bollards/Security/Garden
- Cove/Undershelf/Task
- Indoor/Outdoor Commercial and Residential Architectural
- Automotive Ext (Stop-Tail-Turn, CHMSL, Mirror Side Repeat)
- LCD backlights

Emitter Mechanical Dimensions

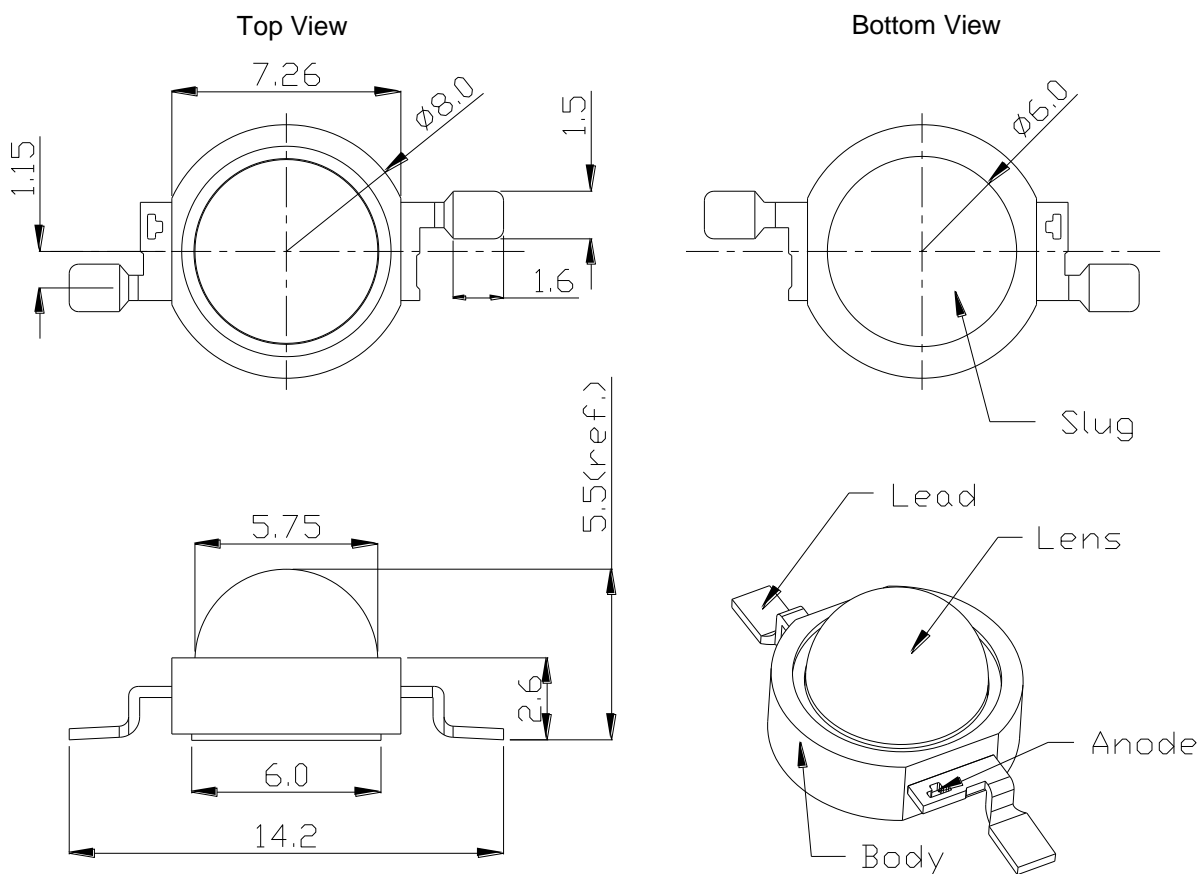

Circuit Diagram (W,WW,G,C,B,D)

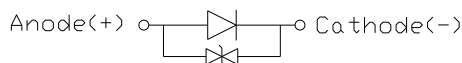

Circuit Diagram (R,A,M,E)

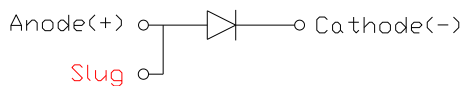

Notes:

1. The Anode side of the device is denoted by a hole in the lead frame.
2. Electrical insulation between the case and the board is required. Do not electrically connect either the anode or cathode to the slug.
3. Drawing not to scale.
4. All dimensions are in millimeters.
5. Unless otherwise indicated, tolerances are $\pm 0.20\text{mm}$.
6. Please do not bend the leads of the LED, otherwise it will damage the LED.
7. **Please do not use a force of over 3kgf impact or pressure on the lens of the LED, otherwise it will cause a catastrophic failure.**

*The appearance and specifications of the product may be modified for improvement without notice.

Flux Characteristics at 350mA, T_J = 25°C

| Radiation Pattern | Color | Part Number Emitter | Luminous Flux or Power | |
|-------------------|------------|---------------------|------------------------|---------|
| | | | Minimum | Typical |
| Lambertian | White | PM2B-1LWE | 110 lm | 154 lm |
| | Warm White | PM2B-1LVE | 110 lm | 146 lm |
| | Red | PM2B-1LRE | 51.7 lm | 67 lm |
| | Amber | PM2B-1LAE | 51.7 lm | 73 lm |
| | Green | PM2B-1LGE | 87.4 lm | 120 lm |
| | Cyan | PM2B-1LCE | 67.2 lm | 87 lm |
| | Blue | PM2B-1LBE | 23.5 lm | 29 lm |
| | Royal Blue | PM2B-1LDE | 515 mW | 630 mW |
| | Crimson | PM2B-1LME | 275 mW | 365 mW |
| | Cherry Red | PM2B-1LEE | 225 mW | 315 mW |

- ProLight maintains a tolerance of $\pm 7\%$ on flux and power measurements.
- Please do not drive at rated current more than 1 second without proper heat sink.

Electrical Characteristics at 350mA, T_J = 25°C

| Color | Forward Voltage V _F (V) | | | Thermal Resistance Junction to Slug (°C/ W) |
|------------|------------------------------------|------|------|---|
| | Min. | Typ. | Max. | |
| White | 2.85 | 3.30 | 3.85 | 10 |
| Warm White | 2.85 | 3.30 | 3.85 | 10 |
| Red | 1.75 | 2.20 | 3.00 | 10 |
| Amber | 1.75 | 2.20 | 3.00 | 10 |
| Green | 2.85 | 3.40 | 3.85 | 10 |
| Cyan | 2.85 | 3.40 | 3.85 | 10 |
| Blue | 2.85 | 3.30 | 3.85 | 10 |
| Royal Blue | 2.85 | 3.30 | 3.85 | 10 |
| Crimson | 1.75 | 2.20 | 3.00 | 10 |
| Cherry Red | 1.50 | 2.00 | 2.75 | 10 |

- ProLight maintains a tolerance of $\pm 0.1V$ for Voltage measurements.

Optical Characteristics at 350mA, T_J = 25°C

| Color | Dominant Wavelength λ_D , Peak Wavelength ^[1] λ_P , or Color Temperature CCT | | | Total included Angle (degrees) $\theta_{0.90V}$ | Viewing Angle (degrees) $2 \theta_{1/2}$ |
|---------------------------------------|---|--------|---------|---|---|
| | Min. | Typ. | Max. | | |
| White | 4100 K | 5500 K | 10000 K | 180 | 130 |
| Warm White | 2700 K | 3300 K | 4100 K | 180 | 130 |
| Red | 613.5 nm | 623 nm | 631 nm | 180 | 130 |
| Amber | 587 nm | 592 nm | 597 nm | 180 | 130 |
| Green | 515 nm | 525 nm | 535 nm | 180 | 130 |
| Cyan | 495 nm | 505 nm | 515 nm | 180 | 130 |
| Blue | 455 nm | 465 nm | 475 nm | 180 | 130 |
| Royal Blue | 450 nm | 455 nm | 460 nm | 180 | 130 |
| Crimson ^[1] ^[2] | 650 nm | 660 nm | 670 nm | 180 | 130 |
| Cherry Red ^[1] | 720 nm | 730 nm | 740 nm | 180 | 130 |

- ProLight maintains a tolerance of ± 1 nm for dominant wavelength measurements.
- ProLight maintains a tolerance of $\pm 5\%$ for CCT measurements.
- ^[1] Crimson, Cherry Red product is binned by peak wavelength rather than dominant wavelength.
- ^[2] The peak wavelength of 660nm should contain the dominant wavelength of around 640nm.

Absolute Maximum Ratings

| Parameter | White/Warm White/Red/Amber/Green/ Cyan/Blue/Royal Blue/Crimson/Cherry Red |
|--|--|
| DC Forward Current (mA) | 350 |
| Peak Pulsed Forward Current (mA) | 500 (less than 1/10 duty cycle@1KHz) |
| ESD Sensitivity (HBM per MIL-STD-883E Method 3015.7) | $\pm 4000V$ (Class III) |
| LED Junction Temperature | 120°C |
| Operating Board Temperature at Maximum DC Forward Current | -40°C - 105°C |
| Storage Temperature | -40°C - 120°C |
| Soldering Temperature | JEDEC 020c 260°C |
| Allowable Reflow Cycles | 3 |
| Reverse Voltage | Not designed to be driven in reverse bias |

Radiometric Power Bin Structure

| Color | Bin Code | Minimum Radiometric Power (mW) | Maximum Radiometric Power (mW) | Available Color Bins |
|------------|----------|--------------------------------|--------------------------------|----------------------|
| Royal Blue | R | 515 | 635 | All |
| | S | 635 | 755 | [¹] |
| Crimson | N | 275 | 335 | All |
| | P | 335 | 435 | All |
| | Q | 435 | 515 | [¹] |
| Cherry Red | M | 225 | 275 | All |
| | N | 275 | 335 | All |
| | P | 335 | 435 | [¹] |

- ProLight maintains a tolerance of $\pm 7\%$ on flux and power measurements.
- The flux bin of the product may be modified for improvement without notice.
- [¹] The rest of color bins are not 100% ready for order currently. Please ask for quote and order possibility.

Photometric Luminous Flux Bin Structure

| Color | Bin Code | Minimum Photometric Flux (lm) | Maximum Photometric Flux (lm) | Available Color Bins |
|------------|----------|-------------------------------|-------------------------------|-----------------------------|
| White | V1 | 110 | 120 | [¹] |
| | V2 | 120 | 130 | All |
| | W1 | 130 | 140 | All |
| | W2 | 140 | 155 | All |
| | X1 | 155 | 170 | Xx, Wx, Vx [¹] |
| Warm White | V1 | 110 | 120 | All |
| | V2 | 120 | 130 | All |
| | W1 | 130 | 140 | All |
| | W2 | 140 | 155 | All |
| | X1 | 155 | 170 | [¹] |
| Red | S1 | 51.7 | 58.9 | All |
| | S2 | 58.9 | 67.2 | All |
| | T1 | 67.2 | 76.6 | [¹] |
| Amber | S1 | 51.7 | 58.9 | All |
| | S2 | 58.9 | 67.2 | All |
| | T1 | 67.2 | 76.6 | All |
| | T2 | 76.6 | 87.4 | [¹] |
| | U1 | 87.4 | 99.6 | [¹] |
| Green | U1 | 87.4 | 99.6 | All |
| | U2 | 99.6 | 113.6 | All |
| | V1 | 113.6 | 129.5 | All |
| | V2 | 129.5 | 147.7 | All |
| | W1 | 147.7 | 168.4 | [¹] |
| Cyan | T1 | 67.2 | 76.6 | All |
| | T2 | 76.6 | 87.4 | All |
| | U1 | 87.4 | 99.6 | [¹] |
| Blue | P | 23.5 | 30.6 | A,1 [¹] |
| | Q | 30.6 | 39.8 | [¹] |

- ProLight maintains a tolerance of $\pm 7\%$ on flux and power measurements.
- The flux bin of the product may be modified for improvement without notice.
- [¹] The rest of color bins are not 100% ready for order currently. Please ask for quote and order possibility.

Color Bin

White and Warm White Binning Structure Graphical Representation

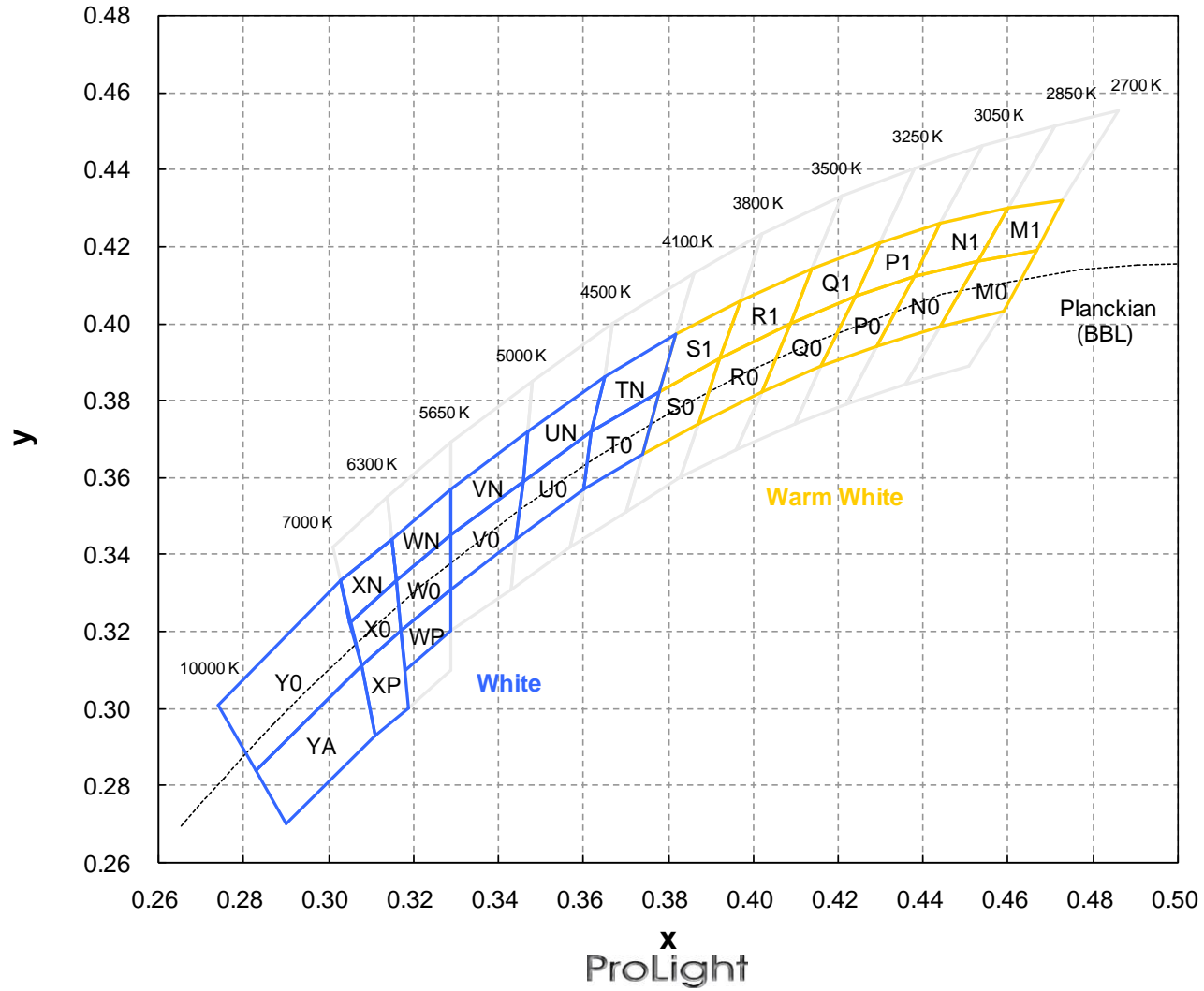

Color Bins

White Bin Structure

| Bin Code | x | y | Typ. CCT (K) | Bin Code | x | y | Typ. CCT (K) |
|----------|-------|-------|--------------|----------|-------|-------|--------------|
| T0 | 0.378 | 0.382 | 4300 | WN | 0.329 | 0.345 | 5970 |
| | 0.374 | 0.366 | | | 0.316 | 0.333 | |
| | 0.360 | 0.357 | | | 0.315 | 0.344 | |
| | 0.362 | 0.372 | | | 0.329 | 0.357 | |
| TN | 0.382 | 0.397 | 4300 | WP | 0.329 | 0.331 | 5970 |
| | 0.378 | 0.382 | | | 0.329 | 0.320 | |
| | 0.362 | 0.372 | | | 0.318 | 0.310 | |
| | 0.365 | 0.386 | | | 0.317 | 0.320 | |
| U0 | 0.362 | 0.372 | 4750 | X0 | 0.308 | 0.311 | 6650 |
| | 0.360 | 0.357 | | | 0.305 | 0.322 | |
| | 0.344 | 0.344 | | | 0.316 | 0.333 | |
| | 0.346 | 0.359 | | | 0.317 | 0.320 | |
| UN | 0.365 | 0.386 | 4750 | XN | 0.305 | 0.322 | 6650 |
| | 0.362 | 0.372 | | | 0.303 | 0.333 | |
| | 0.346 | 0.359 | | | 0.315 | 0.344 | |
| | 0.347 | 0.372 | | | 0.316 | 0.333 | |
| V0 | 0.329 | 0.331 | 5320 | XP | 0.308 | 0.311 | 6650 |
| | 0.329 | 0.345 | | | 0.317 | 0.320 | |
| | 0.346 | 0.359 | | | 0.319 | 0.300 | |
| | 0.344 | 0.344 | | | 0.311 | 0.293 | |
| VN | 0.329 | 0.345 | 5320 | Y0 | 0.308 | 0.311 | 8000 |
| | 0.329 | 0.357 | | | 0.283 | 0.284 | |
| | 0.347 | 0.372 | | | 0.274 | 0.301 | |
| | 0.346 | 0.359 | | | 0.303 | 0.333 | |
| W0 | 0.329 | 0.345 | 5970 | YA | 0.308 | 0.311 | 8000 |
| | 0.329 | 0.331 | | | 0.311 | 0.293 | |
| | 0.317 | 0.320 | | | 0.290 | 0.270 | |
| | 0.316 | 0.333 | | | 0.283 | 0.284 | |

- Tolerance on each color bin (x , y) is ± 0.005

Note: Although several bins are outlined, product availability in a particular bin varies by production run and by product performance. Not all bins are available in all colors.

Color Bins



Warm White Bin Structure

| Bin Code | x | y | Typ. CCT (K) | Bin Code | x | y | Typ. CCT (K) |
|----------|-------|-------|--------------|----------|-------|-------|--------------|
| M0 | 0.453 | 0.416 | 2770 | Q0 | 0.409 | 0.400 | 3370 |
| | 0.444 | 0.399 | | | 0.402 | 0.382 | |
| | 0.459 | 0.403 | | | 0.416 | 0.389 | |
| | 0.467 | 0.419 | | | 0.424 | 0.407 | |
| M1 | 0.460 | 0.430 | 2770 | Q1 | 0.414 | 0.414 | 3370 |
| | 0.453 | 0.416 | | | 0.409 | 0.400 | |
| | 0.467 | 0.419 | | | 0.424 | 0.407 | |
| | 0.473 | 0.432 | | | 0.430 | 0.421 | |
| N0 | 0.438 | 0.412 | 2950 | R0 | 0.392 | 0.391 | 3650 |
| | 0.429 | 0.394 | | | 0.387 | 0.374 | |
| | 0.444 | 0.399 | | | 0.402 | 0.382 | |
| | 0.453 | 0.416 | | | 0.409 | 0.400 | |
| N1 | 0.444 | 0.426 | 2950 | R1 | 0.414 | 0.414 | 3650 |
| | 0.438 | 0.412 | | | 0.409 | 0.400 | |
| | 0.453 | 0.416 | | | 0.392 | 0.391 | |
| | 0.460 | 0.430 | | | 0.397 | 0.406 | |
| P0 | 0.424 | 0.407 | 3150 | S0 | 0.392 | 0.391 | 3950 |
| | 0.416 | 0.389 | | | 0.387 | 0.374 | |
| | 0.429 | 0.394 | | | 0.374 | 0.366 | |
| | 0.438 | 0.412 | | | 0.378 | 0.382 | |
| P1 | 0.430 | 0.421 | 3150 | S1 | 0.397 | 0.406 | 3950 |
| | 0.424 | 0.407 | | | 0.392 | 0.391 | |
| | 0.438 | 0.412 | | | 0.378 | 0.382 | |
| | 0.444 | 0.426 | | | 0.382 | 0.397 | |

- Tolerance on each color bin (x , y) is ± 0.005

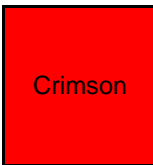

Note: Although several bins are outlined, product availability in a particular bin varies by production run and by product performance. Not all bins are available in all colors.

Peak Wavelength Bin Structure

| Color | Bin Code | Minimum Peak Wavelength (nm) | Maximum Peak Wavelength (nm) |
|---|----------|------------------------------|------------------------------|
|  | 1 | 650 | 655 |
| | 2 | 655 | 660 |
| | 3 | 660 | 665 |
| | 4 | 665 | 670 |
|  | 1 | 720 | 740 |

- ProLight maintains a tolerance of ± 1 nm for peak wavelength measurements.

Dominant Wavelength Bin Structure

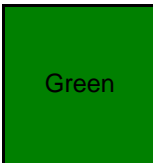
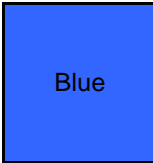
| Color | Bin Code | Minimum Dominant Wavelength (nm) | Maximum Dominant Wavelength (nm) |
|---|----------|----------------------------------|----------------------------------|
|  | 2 | 613.5 | 620.5 |
| | 4 | 620.5 | 631.0 |
|  | 2 | 587.0 | 589.5 |
| | 4 | 589.5 | 592.0 |
| | 6 | 592.0 | 594.5 |
| | 7 | 594.5 | 597.0 |
|  | A | 515 | 520 |
| | 1 | 520 | 525 |
| | 2 | 525 | 530 |
| | 3 | 530 | 535 |
|  | A | 495 | 500 |
| | 1 | 500 | 505 |
| | 2 | 505 | 510 |
| | 3 | 510 | 515 |
|  | A | 455 | 460 |
| | 1 | 460 | 465 |
| | 2 | 465 | 470 |
| | 3 | 470 | 475 |
|  | 5 | 450 | 455 |
| | 6 | 455 | 460 |

- ProLight maintains a tolerance of ± 1 nm for dominant wavelength measurements.

Note: Although several bins are outlined, product availability in a particular bin varies by production run and by product performance. Not all bins are available in all colors.

Forward Voltage Bin Structure

| Color | Bin Code | Minimum Voltage (V) | Maximum Voltage (V) |
|------------|----------|---------------------|---------------------|
| White | A | 2.85 | 3.10 |
| | B | 3.10 | 3.35 |
| | D | 3.35 | 3.60 |
| | E | 3.60 | 3.85 |
| Warm White | A | 2.85 | 3.10 |
| | B | 3.10 | 3.35 |
| | D | 3.35 | 3.60 |
| | E | 3.60 | 3.85 |
| Red | A | 1.75 | 2.00 |
| | B | 2.00 | 2.25 |
| | D | 2.25 | 2.50 |
| | E | 2.50 | 2.75 |
| | F | 2.75 | 3.00 |
| | | | |
| Amber | A | 1.75 | 2.00 |
| | B | 2.00 | 2.25 |
| | D | 2.25 | 2.50 |
| | E | 2.50 | 2.75 |
| | F | 2.75 | 3.00 |
| | | | |
| Green | A | 2.85 | 3.10 |
| | B | 3.10 | 3.35 |
| | D | 3.35 | 3.60 |
| | E | 3.60 | 3.85 |
| Cyan | A | 2.85 | 3.10 |
| | B | 3.10 | 3.35 |
| | D | 3.35 | 3.60 |
| | E | 3.60 | 3.85 |
| Blue | A | 2.85 | 3.10 |
| | B | 3.10 | 3.35 |
| | D | 3.35 | 3.60 |
| | E | 3.60 | 3.85 |
| Royal Blue | A | 2.85 | 3.10 |
| | B | 3.10 | 3.35 |
| | D | 3.35 | 3.60 |
| | E | 3.60 | 3.85 |
| Crimson | A | 1.75 | 2.00 |
| | B | 2.00 | 2.25 |
| | D | 2.25 | 2.50 |
| | E | 2.50 | 2.75 |
| | F | 2.75 | 3.00 |
| | | | |
| Cherry Red | a | 1.50 | 1.75 |
| | A | 1.75 | 2.00 |
| | B | 2.00 | 2.25 |
| | D | 2.25 | 2.50 |
| | E | 2.50 | 2.75 |

- ProLight maintains a tolerance of $\pm 0.1V$ for Voltage measurements.

Note: Although several bins are outlined, product availability in a particular bin varies by production run and by product performance. Not all bins are available in all colors.

Color Spectrum, $T_J = 25^\circ\text{C}$

1. White

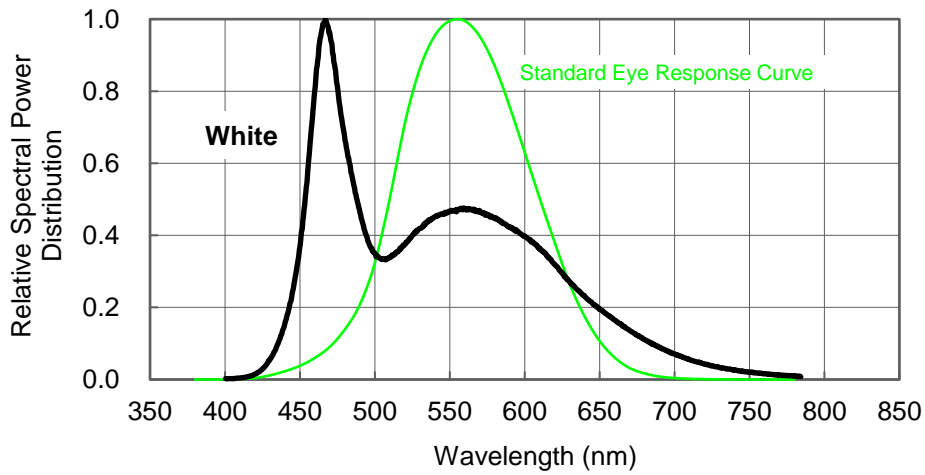

2. Warm White

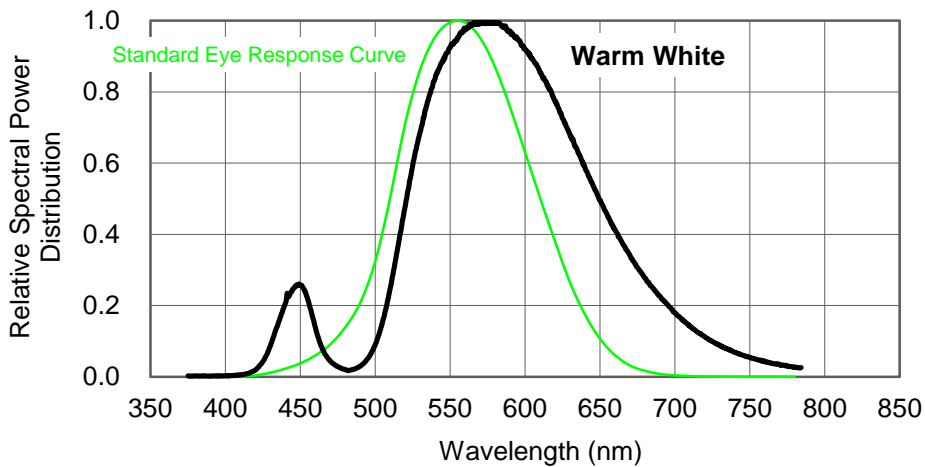

3. Royal Blue 、 Blue 、 Cyan 、 Green 、 Amber 、 Red 、 Crimson 、 Cherry Red

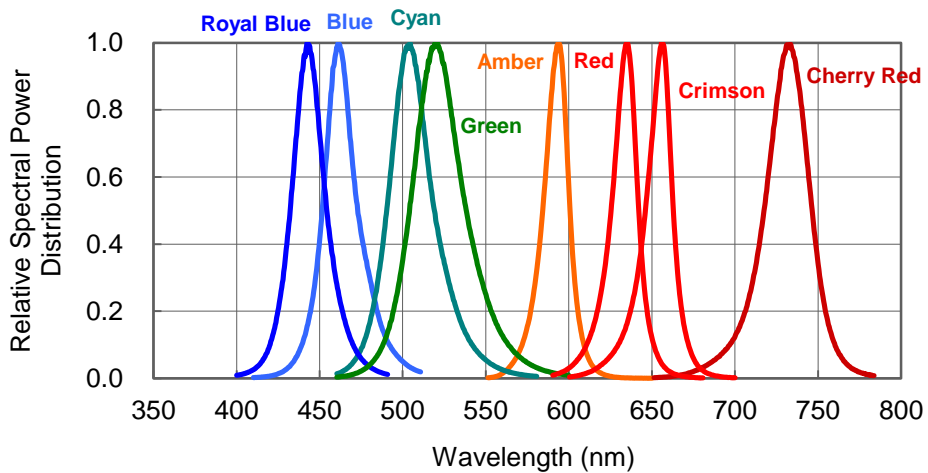

ProLight

Light Output Characteristics

Relative Light Output vs. Junction Temperature at 350mA

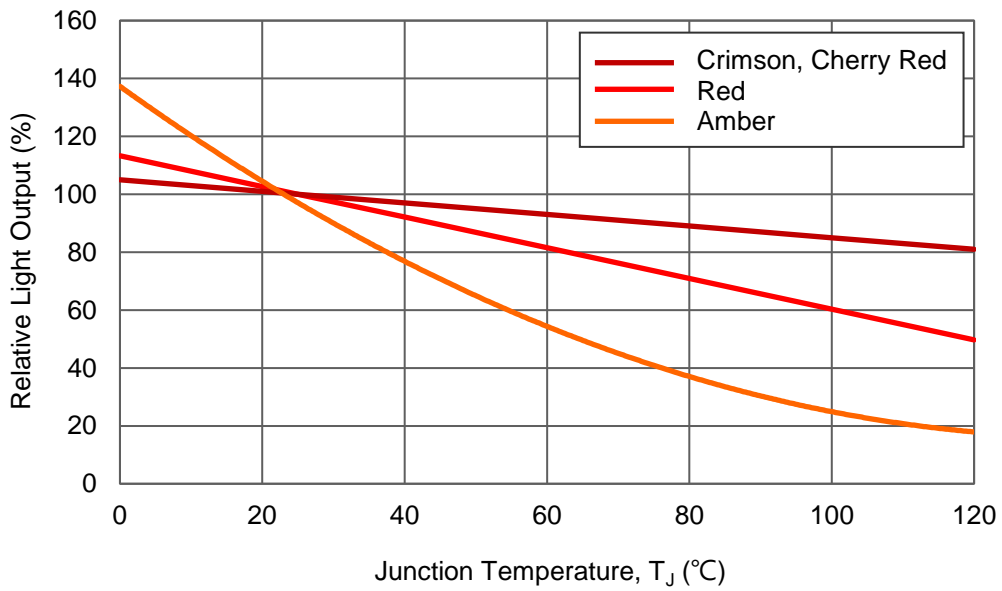
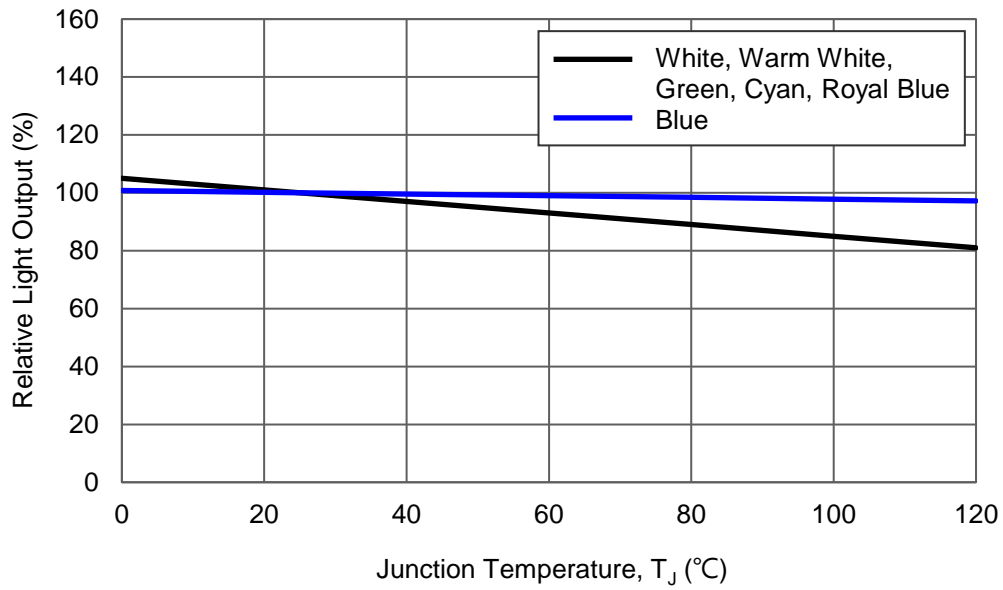

Forward Current Characteristics, $T_J = 25^\circ\text{C}$

1. Forward Voltage vs. Forward Current

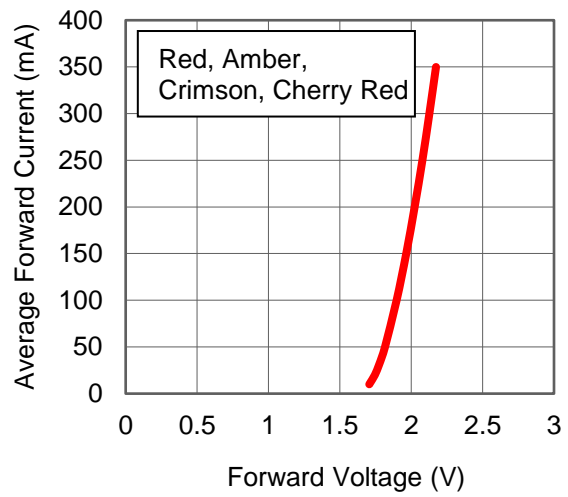
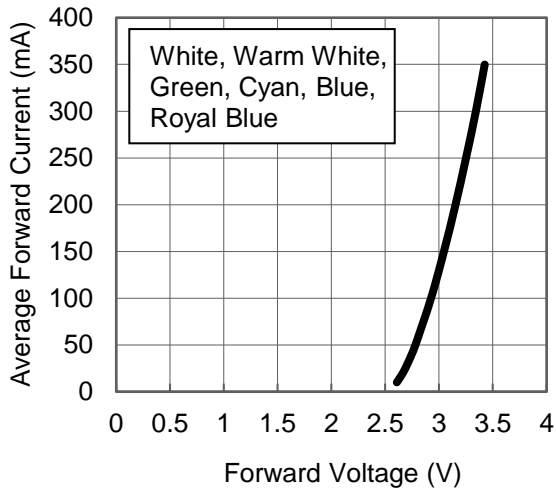

2. Forward Current vs. Normalized Relative Luminous Flux

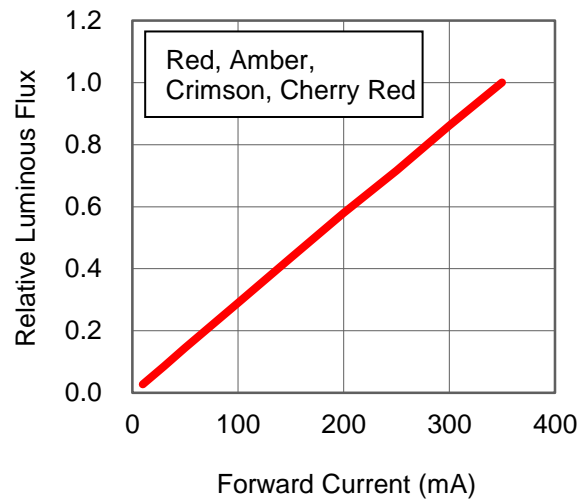
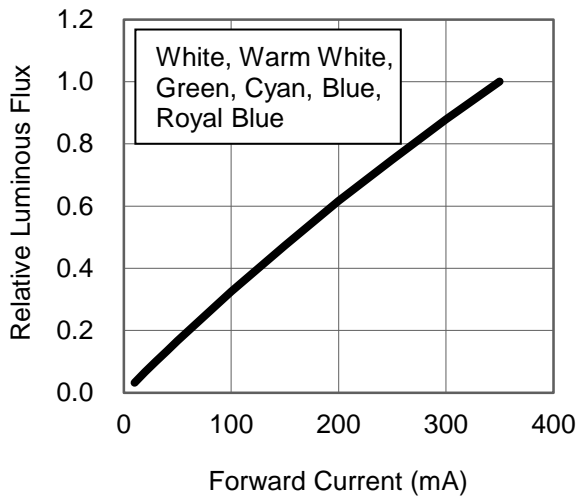

Ambient Temperature vs. Maximum Forward Current

1. White, Warm White, Green, Cyan, Blue, Royal Blue ($T_{JMAX} = 120^{\circ}C$)

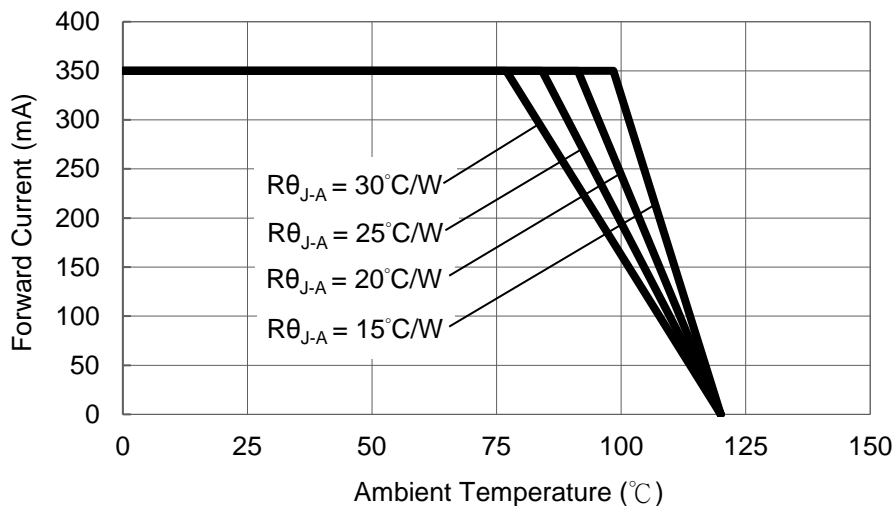

2. Red, Amber, Crimson, Cherry Red ($T_{JMAX} = 120^{\circ}C$)

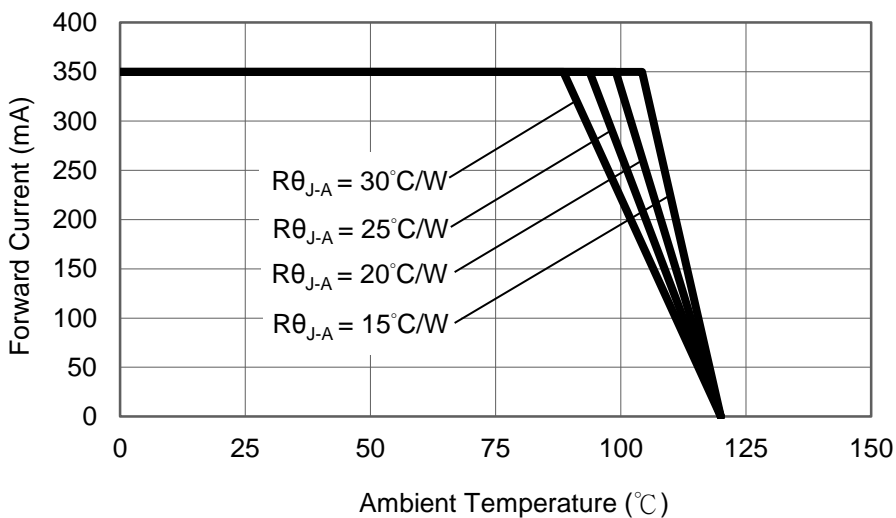

Typical Representative Spatial Radiation Pattern

Lambertian Radiation Pattern

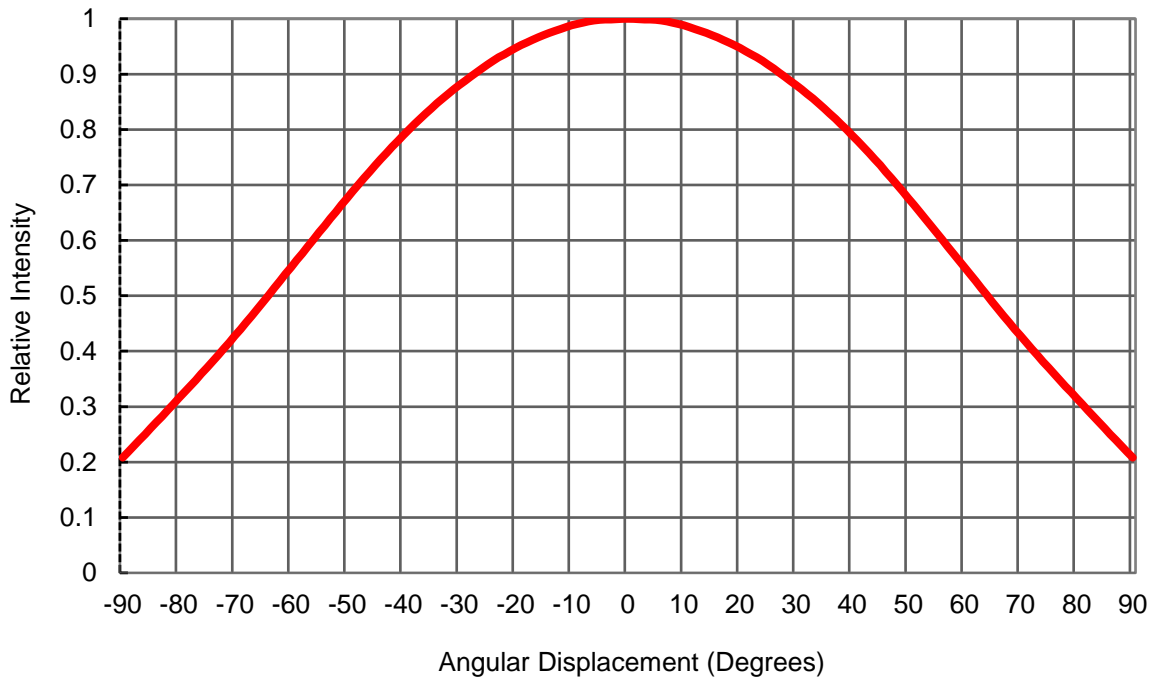

Moisture Sensitivity Level - JEDEC Level 1

| Level | Floor Life | | Soak Requirements | | | |
|-------|------------|-------------------|-------------------|------------------|-------------------------|------------|
| | | | Standard | | Accelerated Environment | |
| | Time | Conditions | Time (hours) | Conditions | Time (hours) | Conditions |
| 1 | Unlimited | ≤30°C / 85% RH | 168 +5/-0 | 85°C / 85% RH | NA | NA |

- The standard soak time includes a default value of 24 hours for semiconductor manufacture's exposure time (MET) between bake and bag and includes the maximum time allowed out of the bag at the distributor's facility.
- Table below presents the moisture sensitivity level definitions per IPC/JEDEC's J-STD-020C.

| Level | Floor Life | | Soak Requirements | | | |
|-------|------------------------|-------------------|------------------------|------------------|-------------------------|------------------|
| | | | Standard | | Accelerated Environment | |
| | Time | Conditions | Time (hours) | Conditions | Time (hours) | Conditions |
| 1 | Unlimited | ≤30°C / 85% RH | 168 +5/-0 | 85°C / 85% RH | NA | NA |
| 2 | 1 year | ≤30°C / 60% RH | 168 +5/-0 | 85°C / 60% RH | NA | NA |
| 2a | 4 weeks | ≤30°C / 60% RH | 696 +5/-0 | 30°C / 60% RH | 120 +1/-0 | 60°C / 60% RH |
| 3 | 168 hours | ≤30°C / 60% RH | 192 +5/-0 | 30°C / 60% RH | 40 +1/-0 | 60°C / 60% RH |
| 4 | 72 hours | ≤30°C / 60% RH | 96 +2/-0 | 30°C / 60% RH | 20 +0.5/-0 | 60°C / 60% RH |
| 5 | 48 hours | ≤30°C / 60% RH | 72 +2/-0 | 30°C / 60% RH | 15 +0.5/-0 | 60°C / 60% RH |
| 5a | 24 hours | ≤30°C / 60% RH | 48 +2/-0 | 30°C / 60% RH | 10 +0.5/-0 | 60°C / 60% RH |
| 6 | Time on Label (TOL) | ≤30°C / 60% RH | Time on Label (TOL) | 30°C / 60% RH | NA | NA |

Qualification Reliability Testing

| Stress Test | Stress Conditions | Stress Duration | Failure Criteria |
|---|--|-----------------|----------------------------|
| Room Temperature Operating Life (RTOL) | 25°C, $I_F = \text{max DC}$ (Note 1) | 1000 hours | Note 2 |
| Wet High Temperature Operating Life (WHTOL) | 85°C/60%RH, $I_F = \text{max DC}$ (Note 1) | 1000 hours | Note 2 |
| Wet High Temperature Storage Life (WHTSL) | 85°C/85%RH, non-operating | 1000 hours | Note 2 |
| High Temperature Storage Life (HTSL) | 110°C, non-operating | 1000 hours | Note 2 |
| Low Temperature Storage Life (LTSL) | -40°C, non-operating | 1000 hours | Note 2 |
| Non-operating Temperature Cycle (TMCL) | -40°C to 120°C, 30 min. dwell, <5 min. transfer | 200 cycles | Note 2 |
| Mechanical Shock | 1500 G, 0.5 msec. pulse, 5 shocks each 6 axis | | Note 3 |
| Natural Drop | On concrete from 1.2 m, 3X | | Note 3 |
| Variable Vibration Frequency | 10-2000-10 Hz, log or linear sweep rate, 20 G about 1 min., 1.5 mm, 3X/axis | | Note 3 |
| Solderability | Steam age for 16 hrs., then solder dip at 260°C for 5 sec. | | Solder coverage on lead |

Notes:

1. Depending on the maximum derating curve.
2. Criteria for judging failure

| Item | Test Condition | Criteria for Judgement | |
|---|-----------------------|------------------------|---------------------|
| | | Min. | Max. |
| Forward Voltage (V_F) | $I_F = \text{max DC}$ | -- | Initial Level x 1.1 |
| Luminous Flux or Radiometric Power (Φ_V) | $I_F = \text{max DC}$ | Initial Level x 0.7 | -- |
| Reverse Current (I_R) | $V_R = 5V$ | -- | 50 μA |

* The test is performed after the LED is cooled down to the room temperature.

3. A failure is an LED that is open or shorted.

Recommended Solder Pad Design

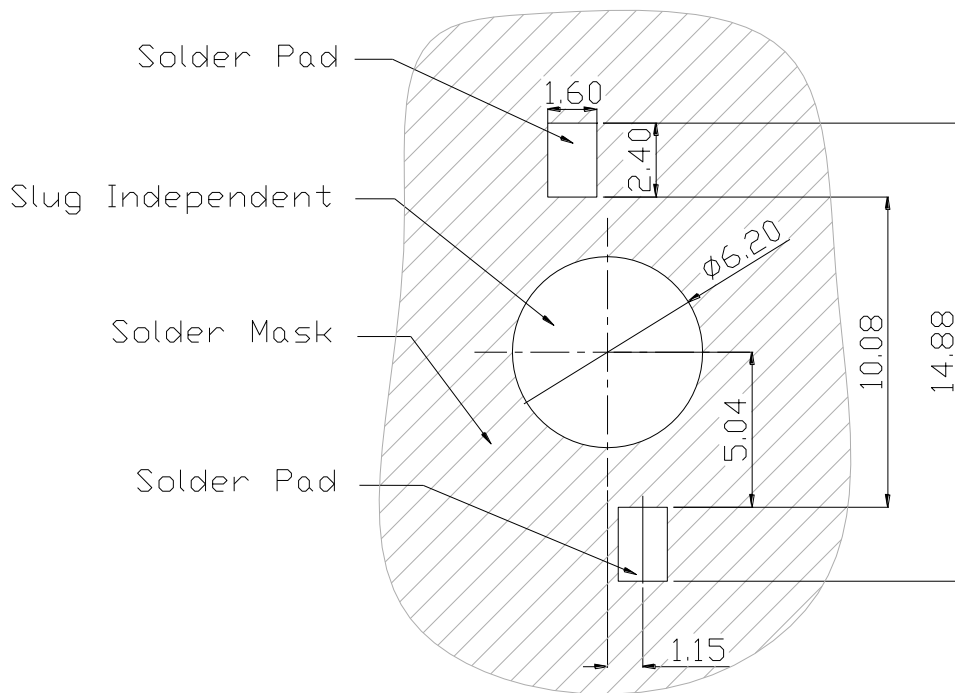

- All dimensions are in millimeters.
- Electrical isolation is required between Slug and Solder Pad.

Reflow Soldering Condition

| Profile Feature | Sn-Pb Eutectic Assembly | Pb-Free Assembly |
|--|----------------------------------|----------------------------------|
| Average Ramp-Up Rate (T_{Smax} to T_P) | 3°C / second max. | 3°C / second max. |
| Preheat – Temperature Min (T_{Smin}) – Temperature Max (T_{Smax}) – Time (t_{Smin} to t_{Smax}) | 100°C 150°C 60-120 seconds | 150°C 200°C 60-180 seconds |
| Time maintained above: – Temperature (T_L) – Time (t_L) | 183°C 60-150 seconds | 217°C 60-150 seconds |
| Peak/Classification Temperature (T_P) | 240°C | 260°C |
| Time Within 5°C of Actual Peak Temperature (t_p) | 10-30 seconds | 20-40 seconds |
| Ramp-Down Rate | 6°C/second max. | 6°C/second max. |
| Time 25°C to Peak Temperature | 6 minutes max. | 8 minutes max. |

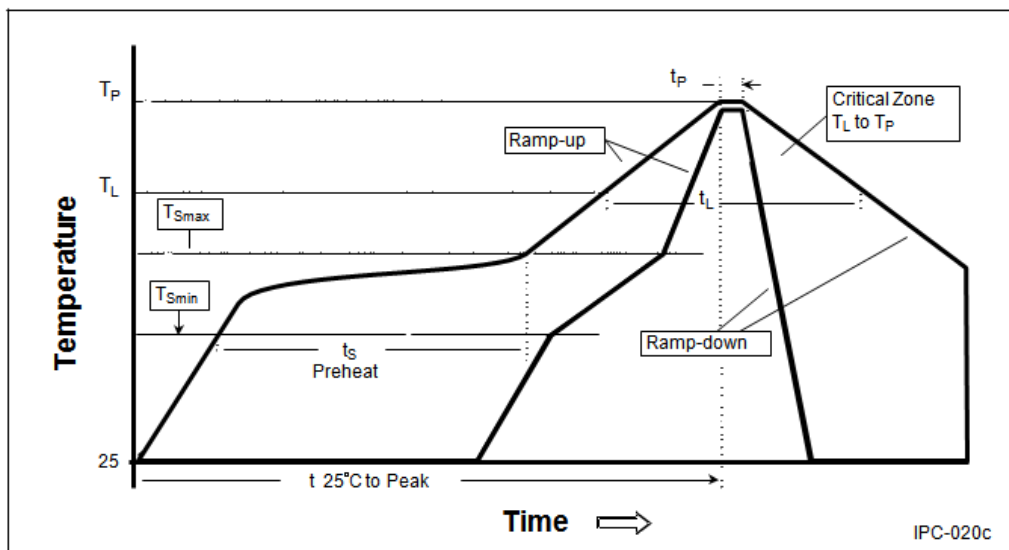

- **We recommend using the M705-S101-S4 solder paste from SMIC (Senju Metal Industry Co., Ltd.) for lead-free soldering.**
- All temperatures refer to topside of the package, measured on the package body surface.
- Repairing should not be done after the LEDs have been soldered. When repairing is unavoidable, a double-head soldering iron should be used. It should be confirmed beforehand whether the characteristics of the LEDs will or will not be damaged by repairing.
- Reflow soldering should not be done more than three times.
- When soldering, do not put stress on the LEDs during heating.
- After soldering, do not warp the circuit board.

Emitter Tube Packaging

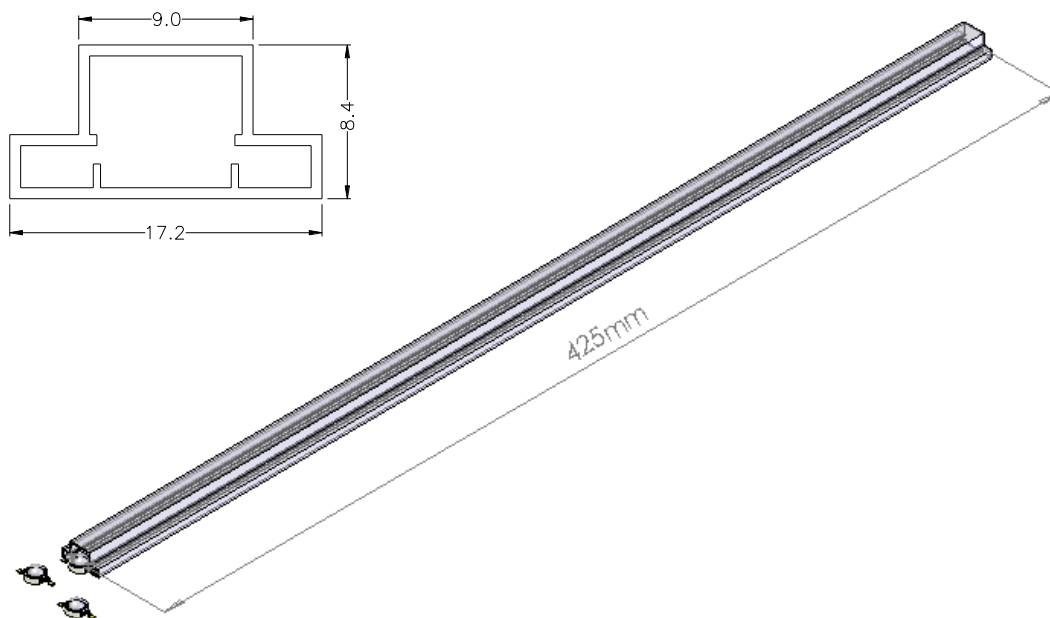

Notes:

1. 50 pieces per tube.
2. Drawing not to scale.
3. All dimensions are in millimeters.
4. All dimensions without tolerances are for reference only.

**Please do not open the moisture barrier bag (MBB) more than one week. This may cause the leads of LED discoloration. We recommend storing ProLight's LEDs in a dry box after opening the MBB. The recommended storage conditions are temperature 5 to 30°C and humidity less than 40% RH.

Precaution for Use

- Storage
Please do not open the moisture barrier bag (MBB) more than one week. This may cause the leads of LED discoloration. We recommend storing ProLight's LEDs in a dry box after opening the MBB. The recommended storage conditions are temperature 5 to 30°C and humidity less than 40% RH. It is also recommended to return the LEDs to the MBB and to reseal the MBB.
- The slug is not electrically neutral. Therefore, we recommend to isolate the heat sink.
- **We recommend using the M705-S101-S4 solder paste from SMIC (Senju Metal Industry Co., Ltd.) for lead-free soldering.**
- Any mechanical force or any excess vibration shall not be accepted to apply during cooling process to normal temperature after soldering.
- Please avoid rapid cooling after soldering.
- Components should not be mounted on warped direction of PCB.
- Repairing should not be done after the LEDs have been soldered. When repairing is unavoidable, a heat plate should be used. It should be confirmed beforehand whether the characteristics of the LEDs will or will not be damaged by repairing.
- This device should not be used in any type of fluid such as water, oil, organic solvent and etc. When cleaning is required, isopropyl alcohol should be used.
- When the LEDs are illuminating, operating current should be decided after considering the package maximum temperature.
- The appearance, specifications and flux bin of the product may be modified for improvement without notice. Please refer to the below website for the latest datasheets.
<http://www.prolightopto.com/>