



Features

- DALI-2 DT6(Dimming) or DT8 (Tunable white/RGBW) control available
- Constant voltage PWM style output with 1 to 4 channels
- Standby power consumption <0.5W
- Flicker free, complying with CE ErP directive
- Plastic housing with class II and PFC design
- Function options: 3 in 1 dimming/DALI-2+PUSH Dimming
- Minimum dimming level 0.1%(DALI-2)
- Cooled by free air convection
- 5 years warranty

Applications

- LED strip lighting(CW/WW/Tunable/RGBW)
- LED decorative lighting
- LED architecture lighting
- Household lighting control system
- DALI Building automation

GTIN CODE

MW Search: <https://www.meanwell.com/serviceGTIN.aspx>

Description

SPWM-150 series is a 150W AC/DC LED driver featuring the constant voltage mode with PWM style output, which is able to maintain the color temperature and the brightness homogeneity when driving all kinds of LED strips. SPWM-150 operates from 100~305VAC and offers models with different rated voltage ranging include 12V and 24V. Thanks to the high efficiency up to 93%,with the fanless design,the entire series is able to operate for -20~+80°C case temperature under free air convection.SPWM-150 is equipped with various function options, such as dimming methodologies with DALI-2 , so as to provide the optimal design flexibility for LED lighting system.

Model Encoding

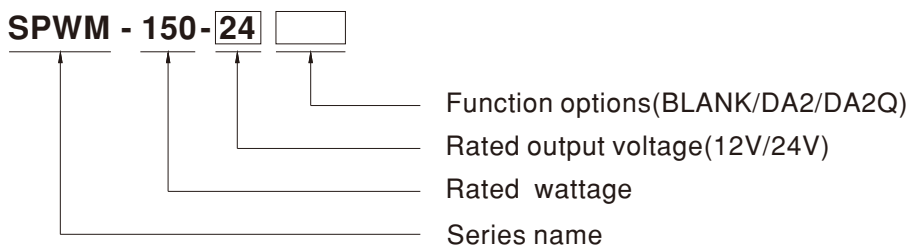

Type	Function	Note
BLANK	3 in 1 dimming function (0~10Vdc,10V PWM signal and resistance)	In stock
DA2	DALI-2 with DT6 control(1 channel output)	In stock
DA2Q	DALI-2 with DT8 control(4 channels output)	In stock

SPECIFICATION		SPWM-150-12□	SPWM-150-24□
OUTPUT			
DC VOLTAGE		12V	24V
RATED CURRENT(Max.)		12.5A	6.3A
RATED POWER(Max.)		150W	151.2W
VOLTAGE ADJ. RANGE		11~14V	23~26V
PWM FREQUENCY (Typ.)		3.2kHz	
SETUP, RISE TIME <small>Note.3</small>		500ms,80ms/230VAC ,1200ms,80ms/115VAC	
HOLD UP TIME (Typ.)		10ms/230VAC or 115VAC	
INPUT			
VOLTAGE RANGE <small>Note.2</small>		100 ~ 305VAC 156 ~ 410VDC (Please refer to "STATIC CHARACTERISTIC" section)	
FREQUENCY RANGE		47 ~ 63Hz	
POWER FACTOR (Typ.)		PF>0.97/115VAC, PF>0.95/230VAC, PF>0.92/277VAC @ full load (Please refer to "POWER FACTOR (PF) CHARACTERISTIC" section)	
TOTAL HARMONIC DISTORTION		THD<10%@load≥50%/115VAC, 230VAC; @load≥75%/277VAC (Please refer to "TOTAL HARMONIC DISTORTION" section)	
EFFICIENCY (Typ.)		92%	93%
AC CURRENT (Typ.)		1.5A/ 115VAC 1A/ 230VAC 0.8A/ 277VAC	
INRUSH CURRENT (Typ.)		COLD START 55A(twidth=500μs measured at 50% Ipeak) at 230VAC; Per NEMA 410	
MAX. NO. of PSUs on 16A CIRCUIT BREAKER		5 units (circuit breaker of type B) / 8 units (circuit breaker of type C) at 230VAC	
LEAKAGE CURRENT		<0.25mA / 277VAC	
STANDBY POWER CONSUMPTION		Standby power consumption<0.5W (Dimming off)	
PROTECTION			
OVERLOAD		105~150%, hiccup mode, recovers automatically after fault condition is removed	
SHORT CIRCUIT		Blank type: Shut down O/P voltage, re-power on to recover after fault condition is removed DA2/DA2Q type:Hiccup mode, recovers automatically after fault condition is removed	
OVER VOLTAGE		15 ~ 20V Shut down O/P voltage, re-power on to recover after fault condition is removed	27~ 36V
OVER TEMPERATURE		Shut down O/P voltage, re-power on to recover after fault condition is removed	
ENVIRONMENT			
WORKING TEMP.		Tcase=-20~+80℃ (Please refer to " OUTPUT LOAD vs TEMPERATURE" section)	
MAX. CASE TEMP.		Tcase=80℃	
WORKING HUMIDITY		20 ~ 95% RH non-condensing	
STORAGE TEMP., HUMIDITY		-40 ~ +80℃, 10 ~ 95% RH	
TEMP. COEFFICIENT		±0.03%/℃ (0 ~ 50℃)	
VIBRATION		5 ~ 100Hz, 2G 12min./1cycle, period for 72min. each along X,Y,Z axes	
SAFETY & EMC			
SAFETY STANDARDS		UL8750(Class P), CSA C22.2 No.250.13-12; ENEC BS EN/EN61347-1, BS EN/EN61347-2-13(EL) appendix J suitable for emergency installations(DC input 176-280VDC), BS EN/EN62384; GB/T19510.1,GB/T19510.213; EAC TP TC 004; Design refer to AS/NZS 61347-1, AS/NZS 61347-2-13	
DALI STANDARDS		Comply with IEC62386-101, 102, 207(DT6),209(DT8),DALI Part 251	
WITHSTAND VOLTAGE		I/P-O/P:3.75KVAC	
ISOLATION RESISTANCE		I/P-O/P:100M Ohms / 500VDC / 25℃ / 70% RH	
EMC EMISSION <small>Note.4</small>	Parameter	Standard	Test Level/Note
	Conducted	BS EN/EN55015(CISPR15) ,GB/T17743	-----
	Radiated	BS EN/EN55015(CISPR15) ,GB/T17743	-----
	Harmonic Current	BS EN/EN61000-3-2 ,GB 17625.1	Class C @load≥50%
	Voltage Flicker	BS EN/EN61000-3-3	-----
EMC IMMUNITY	BS EN/EN61547		
	Parameter	Standard	Test Level/Note
	ESD	BS EN/EN61000-4-2	Level 3, 8KV air ; Level 2, 4KV contact
	Radiated	BS EN/EN61000-4-3	Level 2
	EFT/Burst	BS EN/EN61000-4-4	Level 2
	Surge	BS EN/EN61000-4-5	Level 4, 2KV/Line-Line
	Conducted	BS EN/EN61000-4-6	Level 2
	Magnetic Field	BS EN/EN61000-4-8	Level 2
	Voltage Dips and Interruptions	BS EN/EN61000-4-11:2020	30% dip 10 periods 100% interruption 0.5 periods
OTHERS			
FLICKER <small>Note.9</small>		PstLM ≤ 1, SVM ≤ 0.4	
MTBF		1926.4K hrs min. Telcordia SR-332 (Bellcore) ; 158.1K hrs min. MIL-HDBK-217F (25℃)	
DIMENSION		340*38*28.5mm (L*W*H)	
PACKING		0.40Kg; 30 pcs/ 12.5 Kg/ 0.66 CUFT	
NOTE			
<ol style="list-style-type: none"> All parameters NOT specially mentioned are measured at 230VAC input, rated current and 25℃ of ambient temperature. De-rating may be needed under low input voltages. Please refer to "STATIC CHARACTERISTIC" sections for details. Length of set up time is measured at first cold start. Turning ON/OFF the driver may lead to increase of the set up time. The driver is considered as a component that will be operated in combination with final equipment. Since EMC performance will be affected by the complete installation, the final equipment manufacturers must re-quality EMC Directive on the complete installation again. This series meets the typical life expectancy of >50,000 hours of operation when Tcase, particularly (⊙) point (or TMP, per DLC), is about 75℃ or less. Please refer to the warranty statement on MEAN WELL's website at http://www.meanwell.com The ambient temperature derating of 3.5℃/1000m with fanless models and of 5℃/1000m with fan models for operating altitude higher than 2000m(6500ft). It is not recommended to connect to capacitive loads. Flicker is measured at full load with the light source provided by MEAN WELL. RCM is on a voluntary basis. Non IC classification Independent LED control gear is not suitable for residential installations. Based on IEC 62368-101/102 DALI power on timing and interruption regulations, the set up time needs to test with a DALI controller which can support for DALI power on function, otherwise the set up time will be higher than 0.5 second for DA2 type. 			

Block Diagram

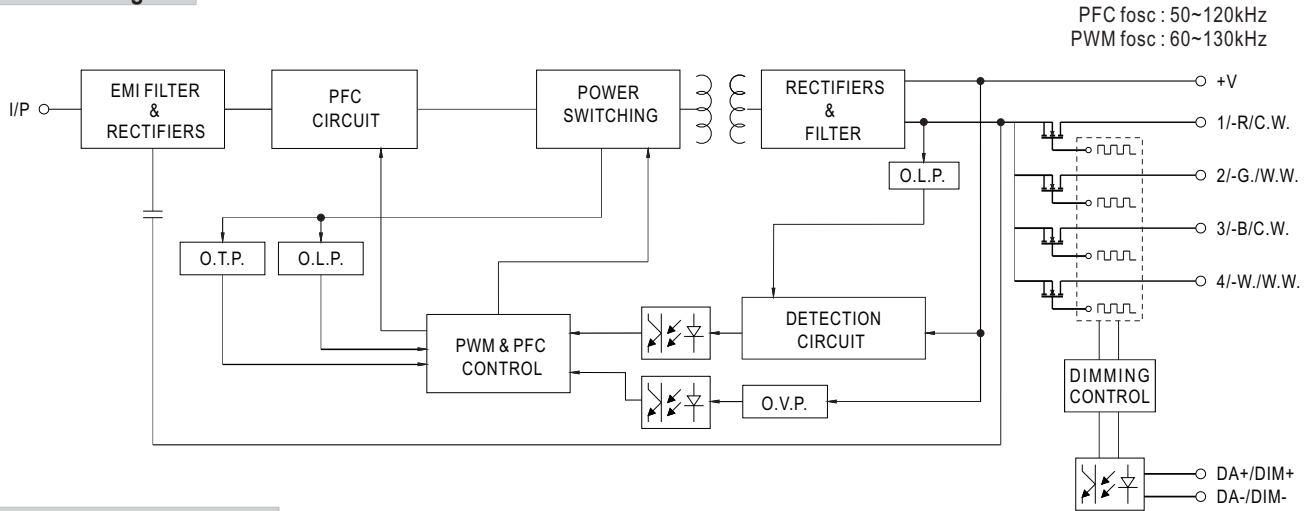

DIMMING OPERATION

※ Dimming principle for PWM style output(1 channel output, for BLANK/DA2 Type)

- Dimming is achieved by varying the duty cycle of the output current.

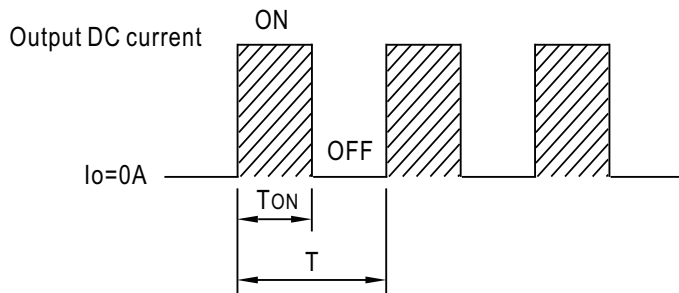

$$\text{Duty cycle(\%)} = \frac{T_{ON}}{T} \times 100\%$$

Output PWM frequency : 3.2kHz fixed

※ Dimming principle for colour temperature dimming and brightness dimming(4 channels output, for DA2Q Type)

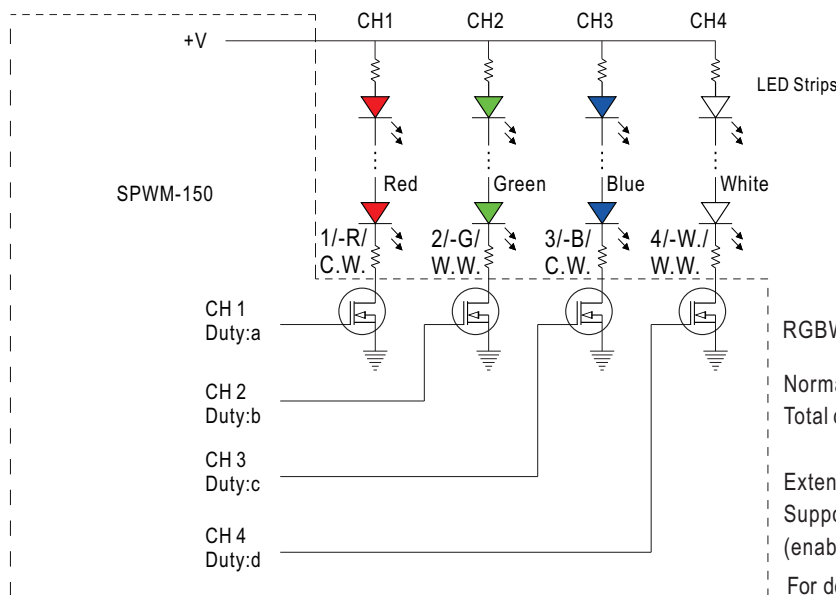

RGBW Mode:

Normalised colour control(Factory default):
Total duty cycle = a + b + c + d ≤ 100%.

Extended Colour Control mode:
Supports a + b + c + d ≤ 400%
(enabled via DALI commands).

For detailed information, Please refer to user manual

※ 3 in 1 dimming function

- Output constant current level can be adjusted by applying one of the three methodologies between DIM+ and DIM-: 0 ~ 10VDC, or 10V PWM signal or resistance.
- Direct connecting to LEDs is suggested. It is not suitable to be used with additional drivers.
- Dimming source current from power supply: 100 μ A (typ.)

◎ Applying additive 0 ~ 10VDC

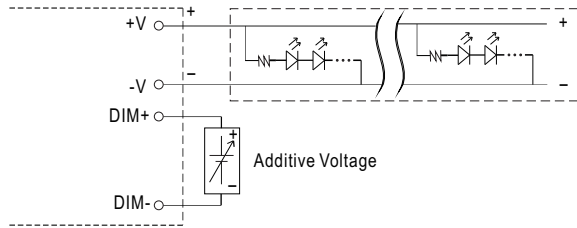

"DO NOT connect "DIM- to -V"

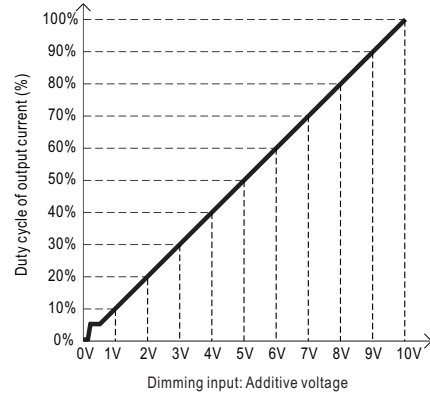

◎ Applying additive 10V PWM signal (frequency range 300Hz~3KHz):

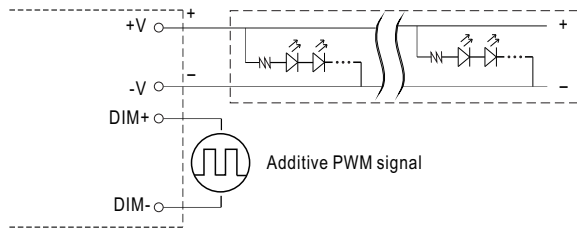

"DO NOT connect "DIM- to -V"

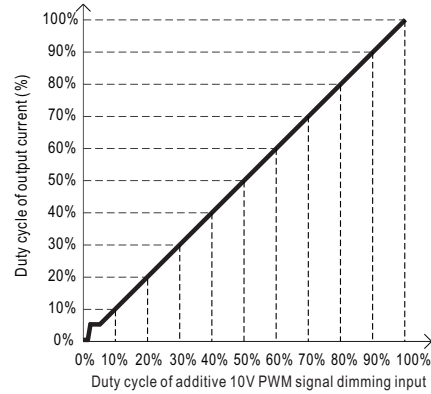

◎ Applying additive resistance: 0~100k Ω

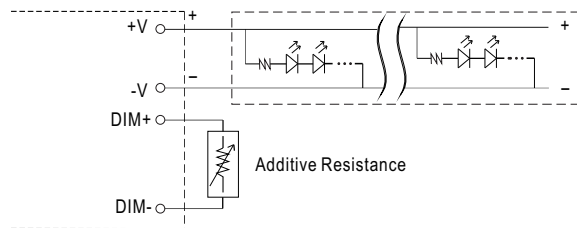

"DO NOT connect "DIM- to -V"

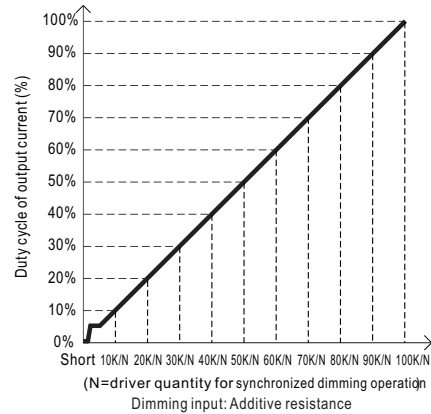

Note : 1. Min. dimming level is about 6% and the output current is not defined when $0\% < I_{out} < 6\%$.

2. The output current could drop down to 0% when dimming input is about 0k Ω or 0Vdc, or 10V PWM signal with 0% duty cycle.

※PUSH dimming (primary side), for DA2/DA2Q Model

- Input wiring diagram

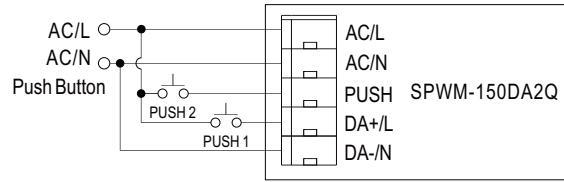
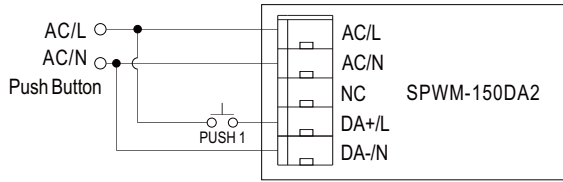

- The factory default dimming level is at 100%.
- Up to 10 drivers can perform the PUSH dimming at the same time when utilizing one common push button.
- The maximum length of the cable from the push button to the last driver is 20 meters.

Action	Action duration
Short Push	0.1~1s
Long Push	>1s

Push Button functionality

Model	Application	Dip Switch			Push 1 for brightness	Push 2 for colour
		1	2	3		
DA2 Type	1 logic unit of LED (DT6, Brightness Dimming)				Short Push : ON/OFF Long Push : Dim up/down. - dim up stop at maximum; dim down stop at minimum dim (not dim off) - with next push, direction change(up/down) - dim up possible even if when unit is OFF	This model does not feature this button.
DA2Q Type	1 logic unit of LED (DT6, Brightness Dimming)	ON	ON	ON	Short Push : ON/OFF Long Push : Dim up/down. - dim up stop at maximum; dim down stop at minimum dim (not dim off) - with next push, direction change(up/down) - dim up possible even if when unit is OFF	Short Push : no response Long Push : no response
	4 logic unit of LED (DT6, Brightness Dimming)	ON	ON	OFF	4 control gears are synchronously controlled Short Push : ON/OFF Long Push : Dim up/down. - dim up stop at maximum; dim down stop at minimum dim (not dim off) - with next push, direction change(up/down) - dim up possible even if when unit is OFF	Short Push : no response Long Push : no response
	1 logic unit of colourtype RGBW (DT8, RGBW colour control) (factory default)	OFF	OFF	OFF	Short Push : ON/OFF Long Push : Dim up/down. - dim up stop at maximum; dim down stop at minimum dim (not dim off) - with next push, direction change(up/down) - dim up possible even if when unit is OFF	Short Push : Switch to "W channel control" or "RGB color control". Long Push : Dimming "W channel control" or "RGB color control". -W channel control: Long press to dim up stop at maximum. Long press to dim down stop at minimum(0). -RGB color control: Long press to change RGB color.
	1 logic unit of colour type Tc (DT8, Tunable white control)	ON	OFF	OFF	Short Push : ON/OFF Long Push : Dim up/down - dim up stop at maximum; dim down stop at minimum dim (not dim off) - with next push, direction change(up/down) - dim up possible even if when unit is OFF	Short Push : ON/OFF Long Push : Dim2Warm - The color temperature warms up while the brightness dims, and the color temperature cools down while the brightness brightens. - dim up stop at maximum; dim down stop at minimum dim (not dim off) - with next push, direction change (up, cooler/down, warmer) - dim up possible even if when unit is OFF



Model		Dip Switch			PUSH 1 for brightness	PUSH 2 for colour
		1	2	3		
DA2Q Type	2 logic units of colour type Tc (DT8, Tunable white control)	OFF	ON	OFF	2 control gears are synchronously controlled Short Push : ON/OFF Long Push : Dim up/down - dim up stop at maximum; dim down stop at minimum dim (not dim off) - with next push, direction change(up/down) - dim up possible even if when unit is OFF	2 control gears are synchronously controlled Short Push : ON/OFF Long Push : Dim2Warm - The color temperature warms up while the brightness dims, and the color temperature cools down while the brightness brightens. - dim up stop at maximum; dim down stop at minimum dim (not dim off) - with next push, direction change (up,cooler/down,warmer) - dim up possible even if when unit is OFF
	2 logic units (1 logic unit of DT6) (1 logic unit of colour type Tc)	OFF	OFF	ON	Only the DT6 device responds Short Push : ON/OFF Long Push : Dim up/down - dim up stop at maximum; dim down stop at minimum dim (not dim off) - with next push, direction change(up/down) - dim up possible even if when unit is OFF	Only the DT8 device responds Short Push : ON/OFF Long Push : Dim2Warm - The color temperature warms up while the brightness dims, and the color temperature cools down while the brightness brightens. - dim up stop at maximum; dim down stop at minimum dim (not dim off) - with next push, direction change (up,cooler/down,warmer) - dim up possible even if when unit is OFF

※ DALI interface(4 channels output, for DA2Q Model)

Dip Switch			Application	Output channels	Output connections schematic diagram												
1	2	3															
ON	ON	ON	1 logic unit of LED (DT6, Brightness Dimming)	1 logical control gear 1 DALI address	<table border="1"> <tr><th colspan="6">Output Terminal</th></tr> <tr> <td>4/-W/ W.W.</td> <td>3/-B/ C.W.</td> <td>2/-G/ W.W.</td> <td>1/-R/ C.W.</td> <td>+V</td> <td>+V</td> </tr> </table>	Output Terminal						4/-W/ W.W.	3/-B/ C.W.	2/-G/ W.W.	1/-R/ C.W.	+V	+V
Output Terminal																	
4/-W/ W.W.	3/-B/ C.W.	2/-G/ W.W.	1/-R/ C.W.	+V	+V												
ON	ON	OFF	4 logic units of LED (DT6, Brightness Dimming)	4 logical control gears 4 DALI addresses	<table border="1"> <tr><th colspan="6">Output Terminal</th></tr> <tr> <td>4/-W/ W.W.</td> <td>3/-B/ C.W.</td> <td>2/-G/ W.W.</td> <td>1/-R/ C.W.</td> <td>+V</td> <td>+V</td> </tr> </table>	Output Terminal						4/-W/ W.W.	3/-B/ C.W.	2/-G/ W.W.	1/-R/ C.W.	+V	+V
Output Terminal																	
4/-W/ W.W.	3/-B/ C.W.	2/-G/ W.W.	1/-R/ C.W.	+V	+V												
OFF	OFF	OFF	1 logic unit of colour type RGBW (DT8, RGBW colour control) (factory default)	1 logical control gear 1 DALI address	<table border="1"> <tr><th colspan="6">Output Terminal</th></tr> <tr> <td>4/-W/ W.W.</td> <td>3/-B/ C.W.</td> <td>2/-G/ W.W.</td> <td>1/-R/ C.W.</td> <td>+V</td> <td>+V</td> </tr> </table>	Output Terminal						4/-W/ W.W.	3/-B/ C.W.	2/-G/ W.W.	1/-R/ C.W.	+V	+V
Output Terminal																	
4/-W/ W.W.	3/-B/ C.W.	2/-G/ W.W.	1/-R/ C.W.	+V	+V												
ON	OFF	OFF	1 logic unit of colour type Tc (DT8, Tunable white control)	1 logical control gear 1 DALI address	<table border="1"> <tr><th colspan="6">Output Terminal</th></tr> <tr> <td>4/-W/ W.W.</td> <td>3/-B/ C.W.</td> <td>2/-G/ W.W.</td> <td>1/-R/ C.W.</td> <td>+V</td> <td>+V</td> </tr> </table>	Output Terminal						4/-W/ W.W.	3/-B/ C.W.	2/-G/ W.W.	1/-R/ C.W.	+V	+V
Output Terminal																	
4/-W/ W.W.	3/-B/ C.W.	2/-G/ W.W.	1/-R/ C.W.	+V	+V												
OFF	ON	OFF	2 logic units of colour type Tc (DT8, Tunable white control)	2 logical control gears 2 DALI addresses	<table border="1"> <tr><th colspan="6">Output Terminal</th></tr> <tr> <td>4/-W/ W.W.</td> <td>3/-B/ C.W.</td> <td>2/-G/ W.W.</td> <td>1/-R/ C.W.</td> <td>+V</td> <td>+V</td> </tr> </table>	Output Terminal						4/-W/ W.W.	3/-B/ C.W.	2/-G/ W.W.	1/-R/ C.W.	+V	+V
Output Terminal																	
4/-W/ W.W.	3/-B/ C.W.	2/-G/ W.W.	1/-R/ C.W.	+V	+V												
OFF	OFF	ON	2 logic units (1 logic unit of DT6) (1 logic unit of colour type Tc)	2 logical control gears 2 DALI addresses	<table border="1"> <tr><th colspan="6">Output Terminal</th></tr> <tr> <td>4/-W/ W.W.</td> <td>3/-B/ C.W.</td> <td>2/-G/ W.W.</td> <td>1/-R/ C.W.</td> <td>+V</td> <td>+V</td> </tr> </table>	Output Terminal						4/-W/ W.W.	3/-B/ C.W.	2/-G/ W.W.	1/-R/ C.W.	+V	+V
Output Terminal																	
4/-W/ W.W.	3/-B/ C.W.	2/-G/ W.W.	1/-R/ C.W.	+V	+V												

OUTPUT LOAD vs TEMPERATURE

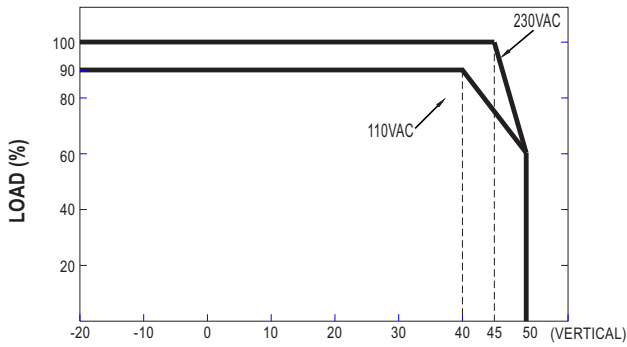

AMBIENT TEMPERATURE, Ta (°C)

Note: Below 110Vac @-20°C there may has restart situation within 5s after power-on.

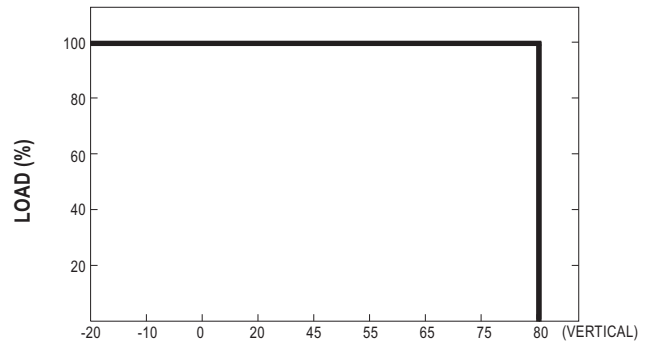

Tcase (°C)

STATIC CHARACTERISTICS

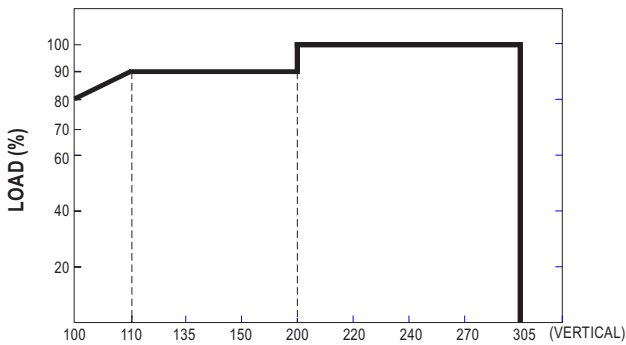

INPUT VOLTAGE (VAC/60HZ)

TOTAL HARMONIC DISTORTION (THD)

※ 24V Model, Tcase at 70°C

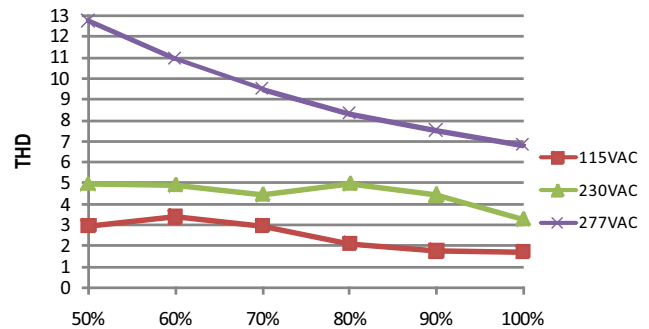

LOAD

POWER FACTOR (PF) CHARACTERISTIC

※ Tcase at 70°C

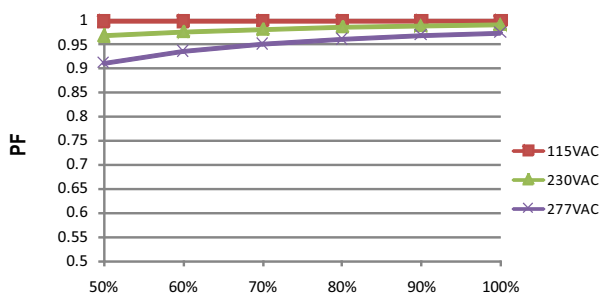

LOAD

EFFICIENCY vs LOAD

SPWM-150 series possess superior working efficiency that up to 93% can be reached in field applications.

※ 24V Model, Tcase at 70°C

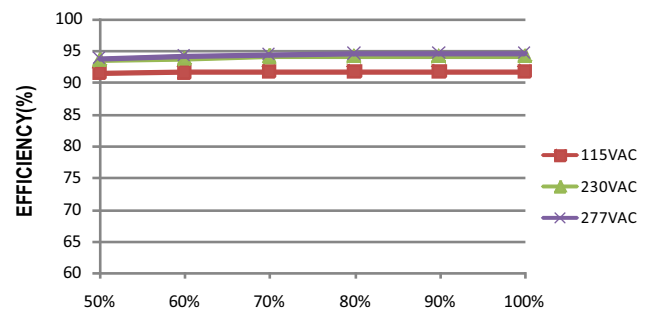

LOAD

■ LIFE TIME

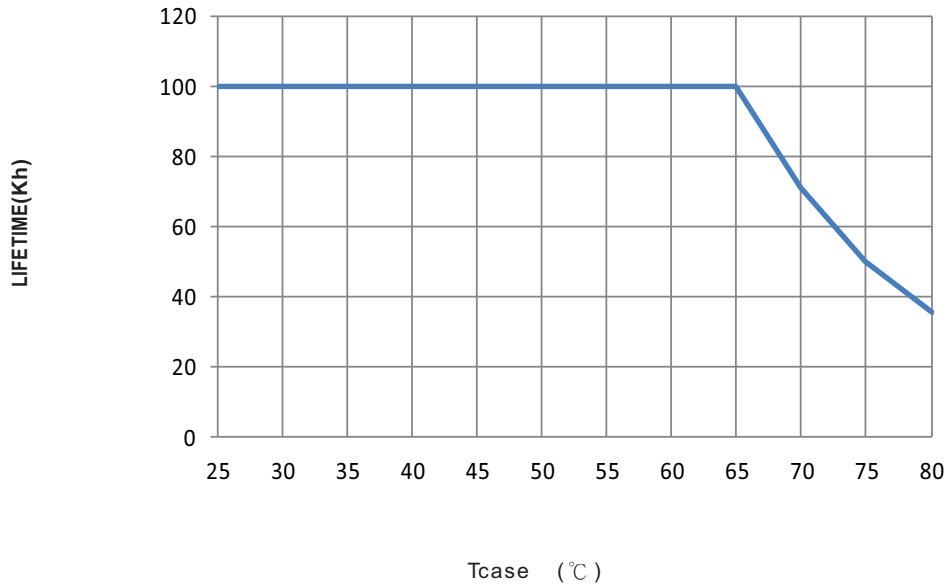

■ Mechanical Specification

※ BLANK -Type

Case No. SPWM-150 Unit:mm Tolerance:±1

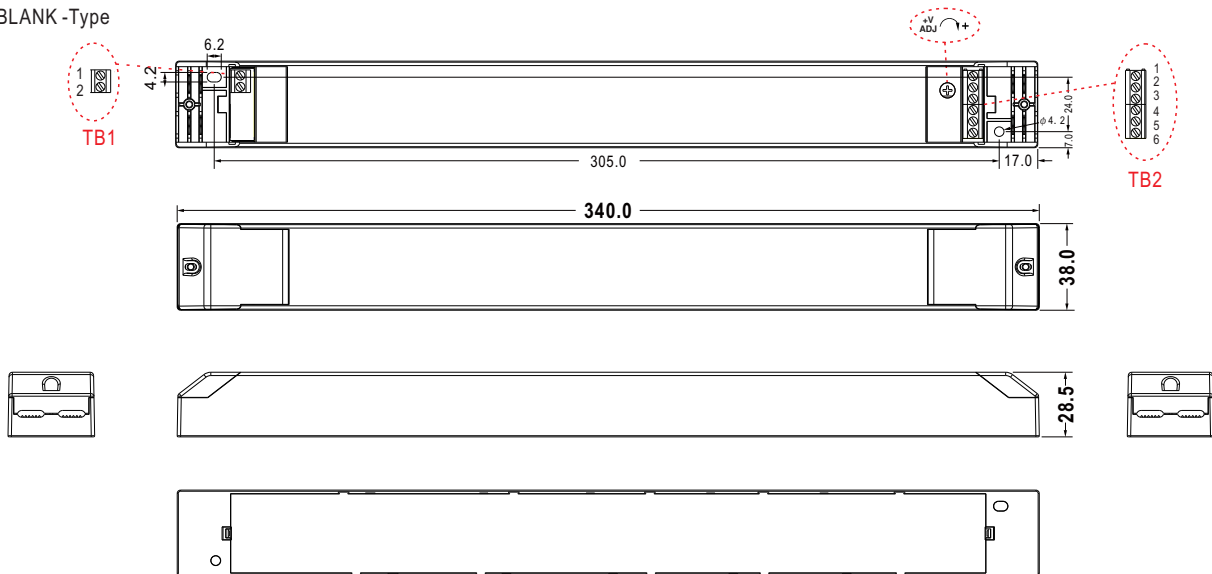

Terminal Pin No. Assignment (TB1):

Pin No.	Assignment
1	AC/L
2	AC/N

TB1 wiring:

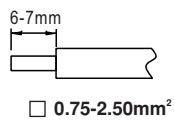

Terminal Pin No. Assignment (TB2):

Pin No.	Assignment
1	+V
2	+V
3	-V
4	-V
5	DIM+
6	DIM-

TB2 wiring:

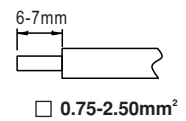

※ DA2-Type

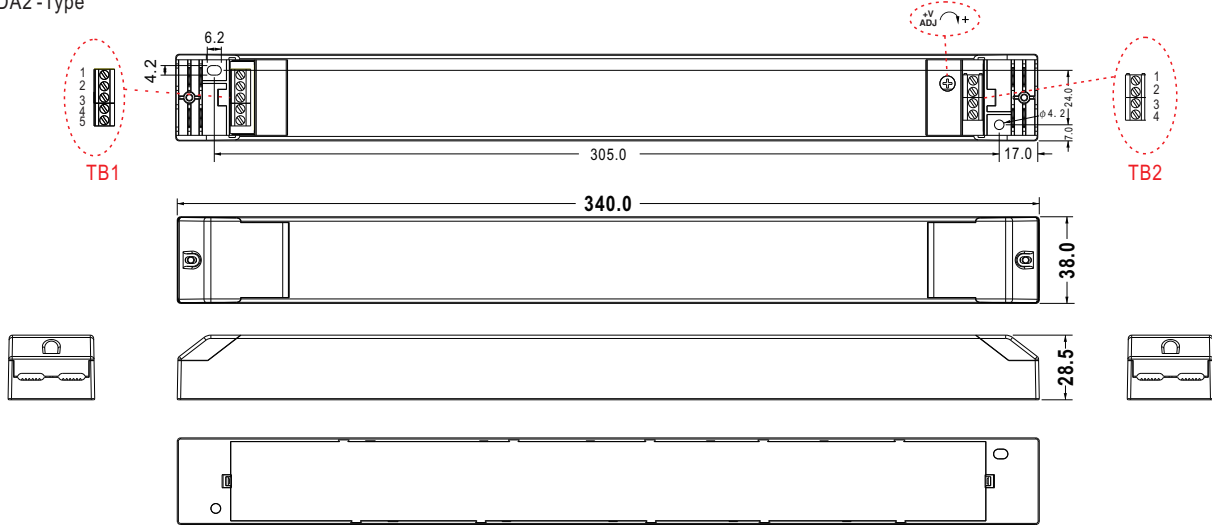

Terminal Pin No. Assignment (TB1):

Pin No.	Assignment
1	AC/L
2	AC/N
3	NC
4	DA+/PUSH
5	DA-/N

TB1 wiring:

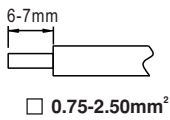

Terminal Pin No. Assignment (TB2):

Pin No.	Assignment
1	+V
2	+V
3	-V
4	-V

TB2 wiring:

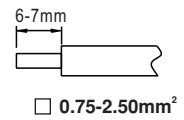

※ DA2Q-Type

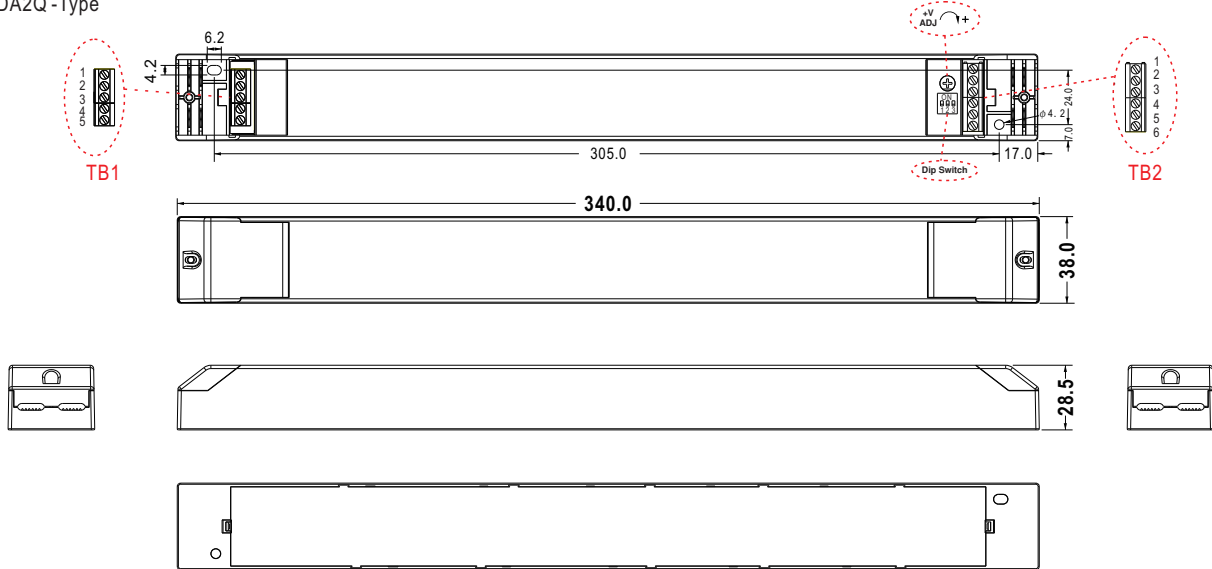

Terminal Pin No. Assignment (TB1):

Pin No.	Assignment
1	AC/L
2	AC/N
3	PUSH/L
4	DA+/L
5	DA-/N

TB1 wiring:

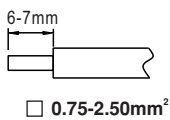

Terminal Pin No. Assignment (TB2):

Pin No.	Assignment
1	+V
2	+V
3	1/-R/C.W.
4	2/-G/W.W.
5	3/-B/C.W.
6	4/-W/W.W.

TB2 wiring:

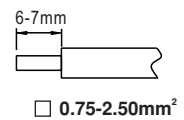

■ INSTALLATION MANUAL

Please refer to : <http://www.meanwell.com/manual.html>