

The logo for DONE, featuring the word "DONE" in a bold, teal, sans-serif font. The letter "D" is stylized with a white circular element on its left side. The logo is enclosed in a thin teal rounded rectangular border.

**DONE**

# MAC SERIES LED DRIVERS

---

DL-40Z-AC-MAC SPEC V1.2

## Features

- Class II structure
- Input voltage: 100-277Vac ~ 50/60Hz
- Efficiency: 88%(Typ.)
- Constant power drive and constant current output control mode
- Plastic shell structure, protection grade: IP67
- Lightning protection level: differential mode 4kV
- Function selection:  
 The output current is fixed and unadjustable
- Lifetime design: 5 years



## Applications

Road lighting、Industrial lighting、Venue lighting  
 Floodlight lighting、Landscape lighting 、Plant lighting



## Model list

Model NO.	Input voltage	Output power	Output voltage	The default current	Eff. ( Typ. )	T.H.D	PF
DL-40Z-AC900-MAC	100-277V 50/60Hz	40W	25-45Vdc	0.9A	≥88%	≤10%	> 0.95
DL-40Z-AC1050-MAC	100-277V 50/60Hz	40W	20-38Vdc	1.05A	≥88%	≤10%	> 0.95
DL-40Z-AC1200-MAC	100-277V 50/60Hz	40W	20-34Vdc	1.2A	≥88%	≤10%	> 0.95

**Note :** Test conditions of the above parameters: Ta=25°C, 230Vac input, full load operation for 30 minutes.

## Input characteristics

Parameter	Min	Typ.	Max	Note
Rated input voltage	100Vac	230Vac	277Vac	
Input voltage range	90Vac	-	305Vac	
Rated frequency	47Hz	50/60Hz	63Hz	
Power factor	0.95	-	-	@230Vac full load
T.H.D.	-	-	10%	@230Vac full load
Input current	-	-	0.6A	@100Vac full load
Inrush current	-	-	60A	230Vac, cold start (25°C)

## Output characteristic

Parameter	Min	Typ.	Max	Note
Rated current				
DL-40Z-AC900-MAC	-	0.9A	-	
DL-40Z-AC1050-MAC	-	1.05A	-	
DL-40Z-AC1200-MAC	-	1.2A	-	
Output voltage range				
DL-40Z-AC900-MAC	25V	-	45V	
DL-40Z-AC1050-MAC	20V	-	38V	
DL-40Z-AC1200-MAC	20V	-	34V	
No-load voltage				
DL-40Z-AC900-MAC	-	-	70V	
DL-40Z-AC1050-MAC	-	-	55V	
DL-40Z-AC1200-MAC	-	-	55V	
Efficiency@100Vac				
DL-40Z-AC900-MAC	86%	87%	-	full load @100Vac
DL-40Z-AC1050-MAC	86%	87%	-	
DL-40Z-AC1200-MAC	86%	87%	-	
Efficiency@230Vac				
DL-40Z-AC900-MAC	87%	88%	-	full load @230Vac
DL-40Z-AC1050-MAC	87%	88%	-	
DL-40Z-AC1200-MAC	87%	88%	-	
Accuracy of output current	-5%	-	+5%	full load
Line regulation	-3%	-	+3%	full load
Load regulation	-3%	-	+3%	full load
Starting time	300ms	-	1000ms	Full load@100-277Vac

**Note:** Input voltage 95-100Vac, current accuracy, linear adjustment rate, load adjustment rate  $\pm 7\%$ .

## Protection

Function		Function instructions			
Input over-voltage protection	Input over-voltage protection	Min.	Typ.	Max.	Notes Turn off the output when the input voltage exceeds protection voltage.
		295Vac	330Vac	350Vac	
	Input over-voltage recovery	Min.	Typ.	Max.	Notes The driver will restart automatically when the input voltage falls below recovery voltage.
		285Vac	290Vac	295Vac	
Output overload protection		Protection mode:hiccup mode,recovers automatically after fault condition is removed.			
Output short circuit protection		Hiccup mode:recovers automatically after fault condition is removed			
Over temperature protection		Self-recovery type :when the housing temperature is greater than 90°C, the output power decreases gradually.			
Output over-voltage protection		Protection mode: Hiccup mode or clamped in output highest voltage, the product is not damaged , LED driver works normally after fault condition is removed.			
Input under-voltage protection		When the input voltage is less than 90Vac, the output power gradually decreases.			

**Note:**

1. Unless otherwise specified, all specifications and parameters shall be measured at the conditions of 230Vac (50Hz), rated load and 25°C of ambient temperature;
2. Including setting error, line regulation and load regulation.

## Environmental

Environmental categories	Parameter
Working temperature	-40 ~ +55°C@200-277Vac, -40 ~ +45°C@100-200Vac (refer to "Life Curve ")
Max.Case Temp.	-40 ~ 90°C
Working humidity	20 ~ 90% RH, non condensing
Storage temperature、 humidity	-40 ~ +80°C, 10 ~ 90% RH
Resistant to vibration	10 ~ 500Hz, 5G 12 min/cycle, X, Y, Z axis 72 min each
MTBF	230Khrs min. MIL-HDBK-217F (Ta=25°C)
Lifetime	50,000 hours @Tcase≤75°C, 230Vac, 80% Load. Please refer to "Tcase VS Lifetime" section.

## Safety and EMC

Safety categories	Standard
Safety	GB19510.1、GB19510.14、EN61347-1、EN61347-2-13、IEC61347-1、IEC61347-2-13、AS/NZS61347.1、AS61347.2.13、EN 62384、UL8750;
EMC	EN 55015、EN 61000-3-2 、GB/T 17743、GB17625.1、 EN 61000-3-3
Surge protection	Differential mode L-N±4KV(2 Ohm). Refer to IEC61000-4-5 2014 Criterion B
High-pot test	I/P-O/P: 3.75KVac
Insulation impedance	I/P-O/P:100MΩ/500VDC / 25°C/70% RH
Leakage current	<0.7mA@277Vac

**Note:** The driver is considered as a component that will be operated in combination with the final equipment. Since EMC performance will be affected by the complete installation, the final equipment manufacturers must re-qualify EMC Directive on the complete installation again.

Eff. VS Output voltage ( DL-40Z-AC900-MAC )

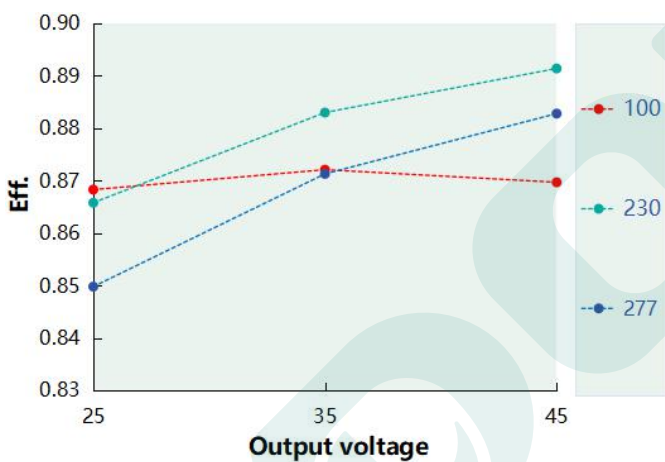

Eff. VS Output voltage ( DL-40Z-AC1050-MAC )

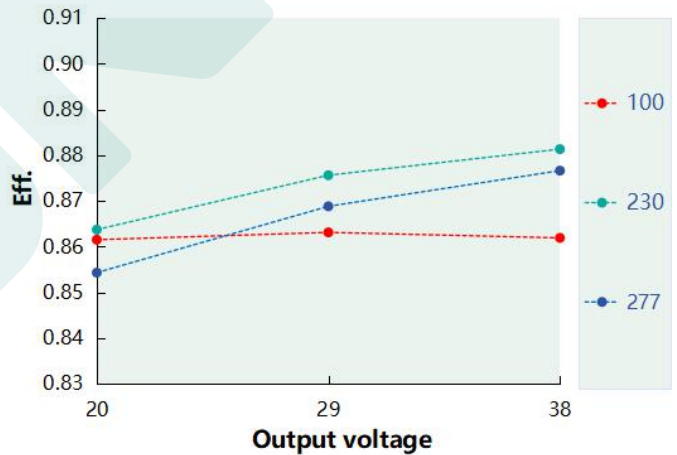

Eff. VS Output voltage ( DL-40Z-AC1200-MAC )

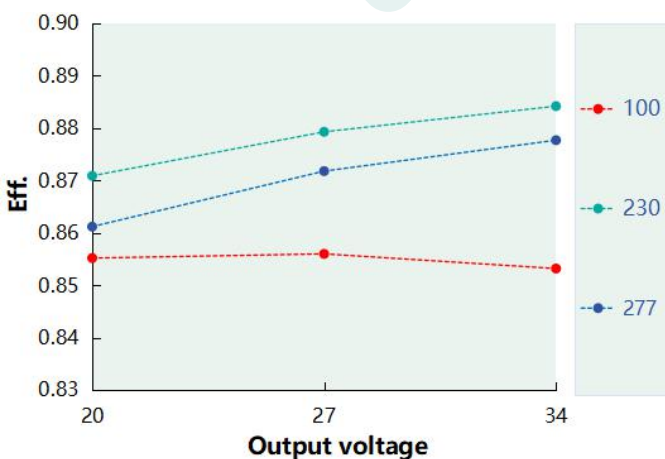

Power Factor VS Input Voltage ( DL-40Z-AC900-MAC )

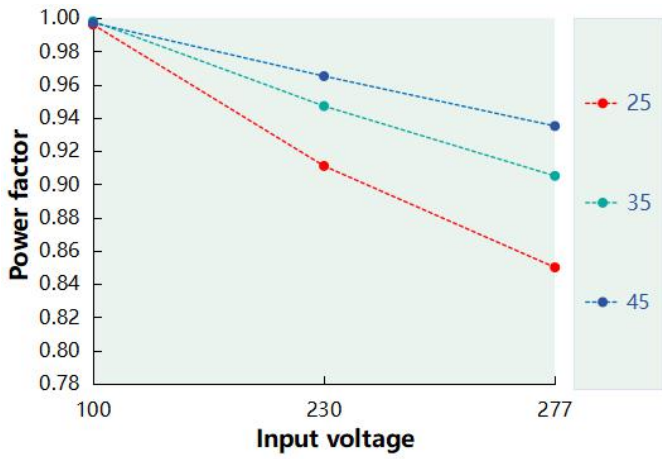

Power Factor VS Input Voltage ( DL-40Z-AC1050-MAC )

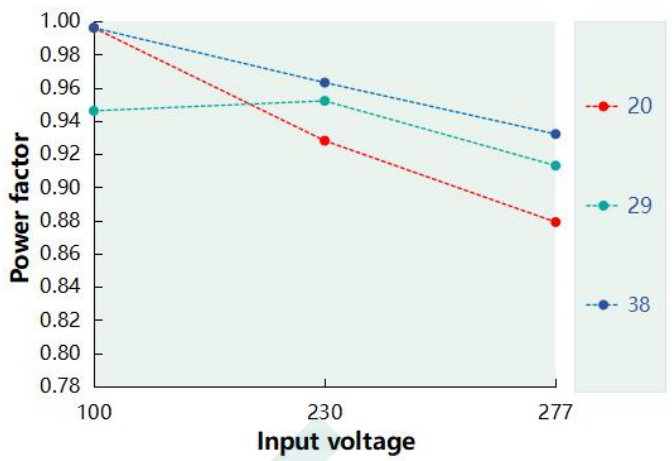

Power Factor VS Input Voltage ( DL-40Z-AC1200-MAC )

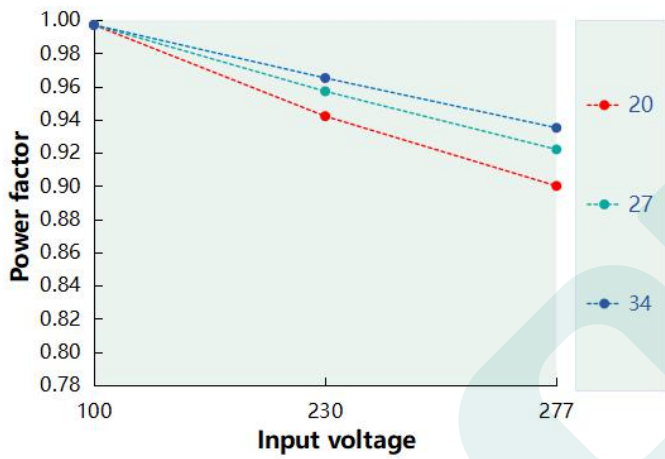

T.H.D. VS Output voltage ( DL-40Z-AC900-MAC )

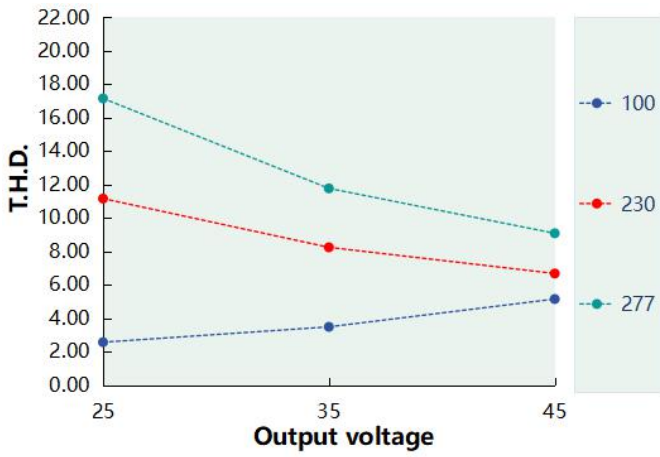

T.H.D. VS Output voltage ( DL-40Z-AC1050-MAC )

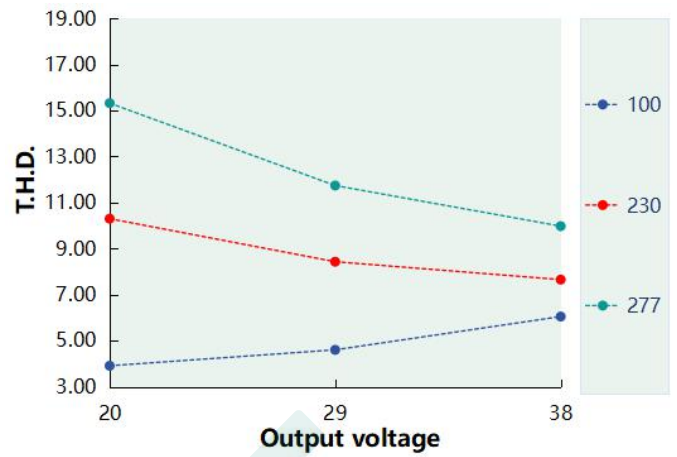

T.H.D. VS Output voltage ( DL-40Z-AC1200-MAC )

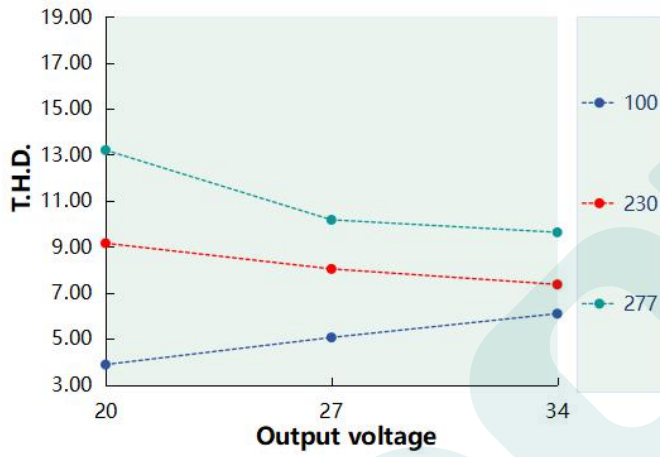

Lifetime VS Tcase ( DL-40Z-AC-MAC )

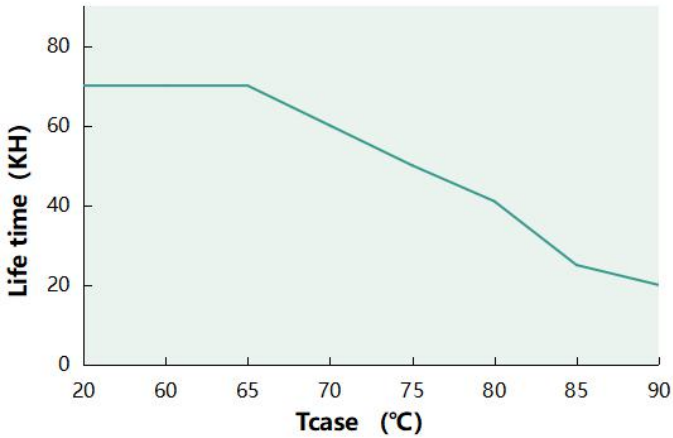

Output power VS Tcase ( DL-40Z-AC-MAC )

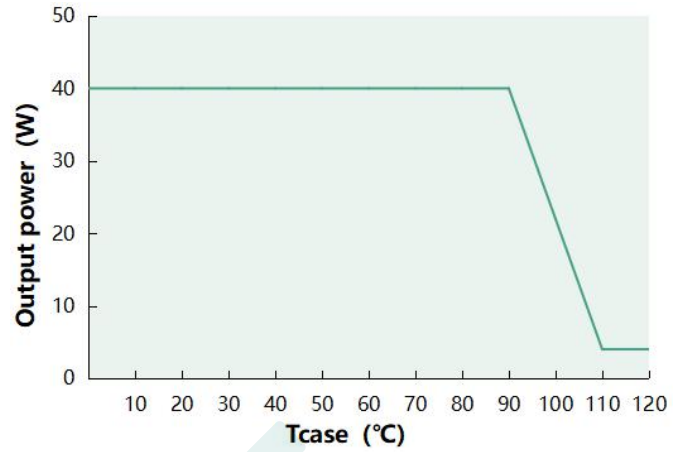

Inrush Current ( DL-40Z-AC-MAC )

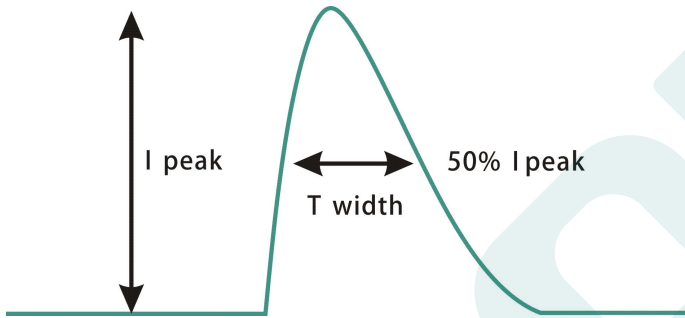

Input voltage	Peak current	T(@50% Peak current)
100Vac	16.8A	42us
230Vac	39A	67us
277Vac	40A	72us

## Mechanical specification

Size ( mm )	L76*W64*H32
-------------	-------------

DL-40Z-AC-MAC

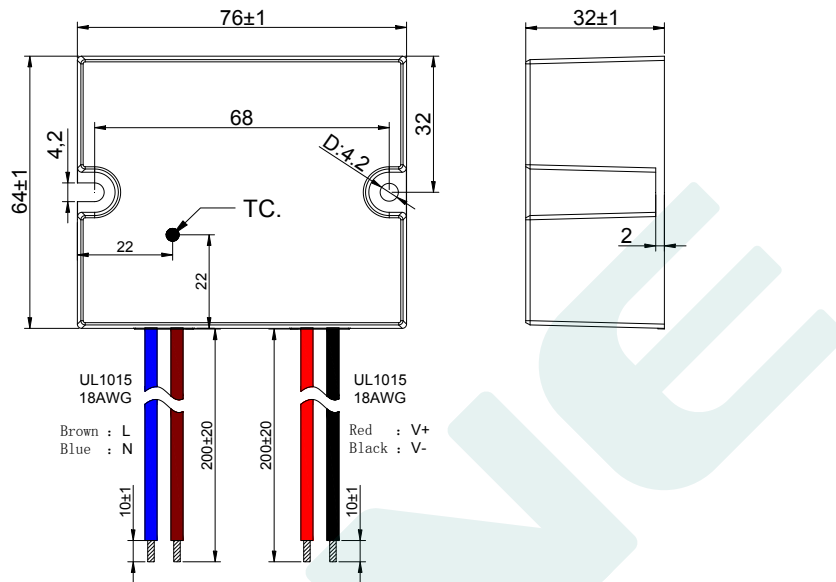

## Weight

Weight	175g
--------	------

## Packaging

Packaging ( mm ) L475\*W350\*H160

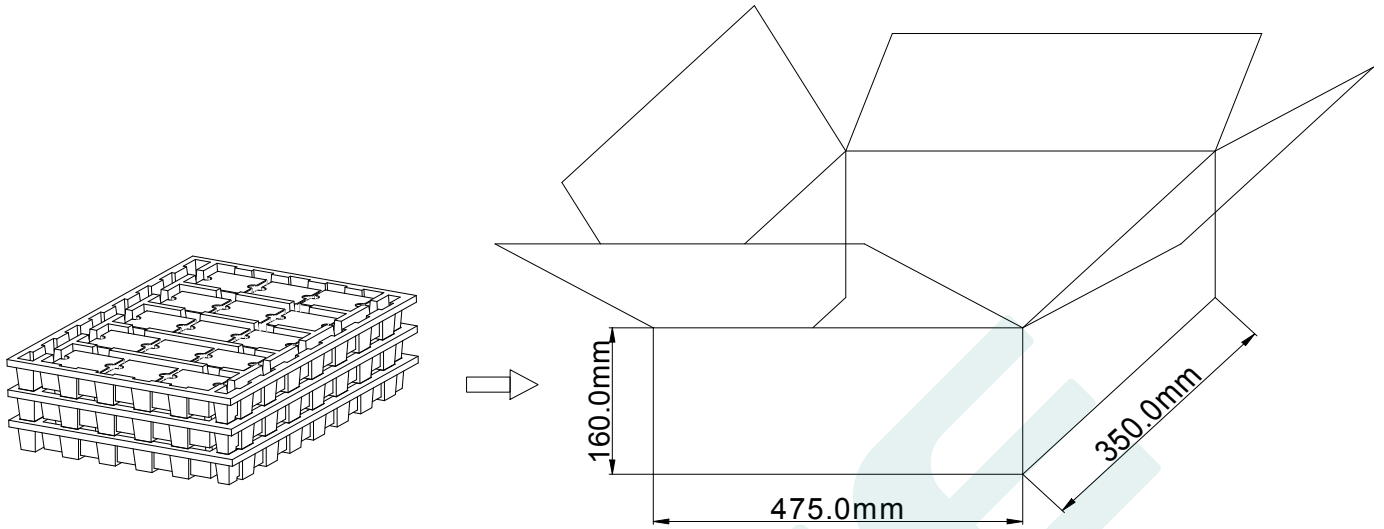

Note: One Carton 3 layers and 15 pcs each layer, total 45 pcs/carton.

**Note:**

1. According to the certificate obtained by the LED DRIVER, the LED DRIVER with the English label is sold in Europe, America and India.
2. The LED DRIVER with Chinese label is only used for China market.

Version

DATE	DESCRIPTION	REV.	CHECK
2025.1.13	Initial version.	V1.0	
2025.4.12	Modify input current.	V1.1	
2025.6.14	Protection grade change to IP67	V1.2	

MANUFACTURER

EDIT	CHECK	APPROVE