

The logo for DONE, featuring the word "DONE" in a bold, teal, sans-serif font. The letter "D" is stylized with a white circular element on its left side. The logo is enclosed in a thin teal rounded rectangular border.

DONE

MAC SERIES LED DRIVERS

DL-30Z-AC-MAC SPEC V1.2

Features

- Class II structure
- Input voltage: 100-277 V ~ 50/60 Hz
- Efficiency :87.5%(Typ.)
- Constant current output control mode
- plastic shell structure, protection grade: IP67
- Lightning protection level: differential mode 4kV
- Function selection:
 The output current is fixed and unadjustable
- Lifetime design: 5years



Applications

Road lighting、Industrial lighting、Venue lighting
 Floodlight lighting、Landscape lighting 、Plant lighting



Model list

Model NO.	Input voltage	Output power	Output voltage	The default current	Eff.	T.H.D	PF
DL-30Z-AC600-MAC	AC 100-277V 50/60Hz	30W	25-50Vdc	0.6A	≥87.5%	≤10%	≥0.95
DL-30Z-AC750-MAC	AC 100-277V 50/60Hz	30W	20-42Vdc	0.75A	≥87.5%	≤10%	≥0.95
DL-30Z-AC900-MAC	AC 100-277V 50/60Hz	30W	20-36Vdc	0.9A	≥87.5%	≤10%	≥0.95

Note : Test conditions of the above parameters: Ta=25°C, 230Vac input, full load operation for 30 minutes;

Input characteristics

Parameter	Min	Typ.	Max	Note
Rated input voltage	100Vac	230Vac	277Vac	
Input voltage range	95Vac		300Vac	
Rated frequency	47Hz	50/60Hz	63Hz	
Power factor	0.95	-	-	@230Vac full load, rated input voltage
T.H.D.	-	-	10%	@230Vac full load
Input current	-	-	0.5A	@100Vac full load
Inrush current	-	-	60A	230Vac, cold start (25°C)

Output characteristic

Parameter	Min	Typ.	Max	Note
Rated current				
DL-30Z-AC600-MAC		0.6A		
DL-30Z-AC750-MAC	-	0.75A	-	
DL-30Z-AC900-MAC		0.9A		
Output voltage range				
DL-30Z-AC600-MAC	25V		50V	
DL-30Z-AC750-MAC	20V	-	42V	
DL-30Z-AC900-MAC	20V		36V	
No-load voltage				
DL-30Z-AC600-MAC			70V	
DL-30Z-AC750-MAC	-	-	55V	
DL-30Z-AC900-MAC			55V	
Efficiency@100Vac				
DL-30Z-AC600-MAC	83.5%	85%	-	full load@100Vac
DL-30Z-AC750-MAC	83.5%	85%		
DL-30Z-AC900-MAC	83.5%	85%		
Efficiency@230Vac				
DL-30Z-AC600-MAC	87%	87.5%	-	full load@230Vac
DL-30Z-AC750-MAC	87%	87.5%		
DL-30Z-AC900-MAC	87%	87.5%		
Accuracy of output current	-5%	-	+5%	full load@100-277Vac
Line regulation	-3%	-	+3%	@100-277Vac
Load regulation	-3%	-	+3%	@100-277Vac
Starting time	300ms	-	1000ms	Full load@100-277Vac

Note: Input voltage 95-100Vac, current accuracy, linear adjustment rate, load adjustment rate $\pm 7\%$.

Protection

Function		Function instructions			
Input over-voltage protection	Input over-voltage protection	Min.	Typ.	Max.	Notes
		295Vac	330Vac	350Vac	Turn off the output when the input voltage exceeds protection voltage.
	Input over-voltage recovery	Min.	Typ.	Max.	Notes
		285Vac	290Vac	295Vac	The driver will restart automatically when the input voltage falls below recovery voltage.
Output overload protection		Protection mode:hiccup mode,recovers automatically after fault condition is removed.			
Output short circuit protection		Hiccup mode:recovers automatically after fault condition is removed			
Over temperature protection		Self-recovery type :when the housing temperature is greater than 93°C, the output power decreases gradually.			
Output over-voltage protection		Protection mode: Hiccup mode or clamped in output highest voltage , the product is not damaged , LED driver works normally after fault condition is removed.			
Input under-voltage protection		When the input voltage is less than 90Vac, the output power gradually decreases.			

Note:

1. Unless otherwise specified, all specifications and parameters shall be measured at the conditions of 230Vac (50Hz), rated load and 25°C of ambient temperature;
2. Including setting error, line regulation and load regulation.

Environmental

Environmental categories	Parameter
Working temperature	-40 ~ +55°C@200-277Vac, -40 ~ +45°C @100-200Vac (refer to "Life Curve ")
Max.Case Temp.	-40 ~ 90°C
Working humidity	20 ~ 95% RH, non condensing
Storage temperature、 humidity	-40 ~ +80°C, 10 ~ 95% RH
Resistant to vibration	10 ~ 500Hz, 5G 12 min/cycle, X, Y, Z axis 72 min each
MTBF	230Khrs min. MIL-HDBK-217F (Ta=25°C)
Lifetime	50000 hours @Tcase≤75°C,230Vac, 80% Load, Please refer to "Tcase VS Lifetime" section

Safety and EMC

Safety categories	Standard
Safety	GB19510.1、GB19510.14、EN61347-1、EN61347-2-13、IEC61347-1、IEC61347-2-13、AS/NZS61347.1、AS61347.2.13、EN 62384、UL8750
EMC	EN 55015、EN 61000-3-2 、GB/T 17743、GB17625.1、EN 61000-3-3
Surge protection	Differential mode L-N $\pm 4KV$ (2 ohm) ,Refer to IEC61000-4-5 2014 Criterion B
High-pot test	I/P-O/P:3.75KVac
Insulation impedance	I/P-PE:100M Ω / 500VDC; I/P-O/P:100M Ω / 500VDC / 25°C/ 70% RH
Leakage current	<0.7mA@277Vac

Note: The driver is considered as a component that will be operated in combination with the final equipment. Since EMC performance will be affected by the complete installation,the final equipment manufacturers must re-qualify EMC Directive on the complete installation again.

Eff. VS Output voltage(DL-30Z-AC600-MAC)

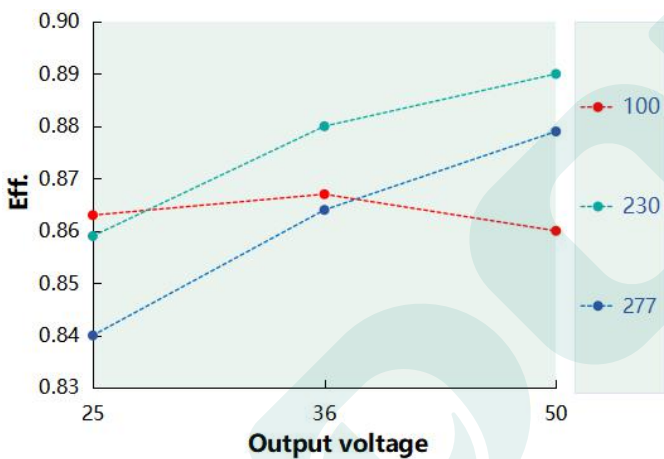

Eff. VS Output voltage(DL-30Z-AC750-MAC)

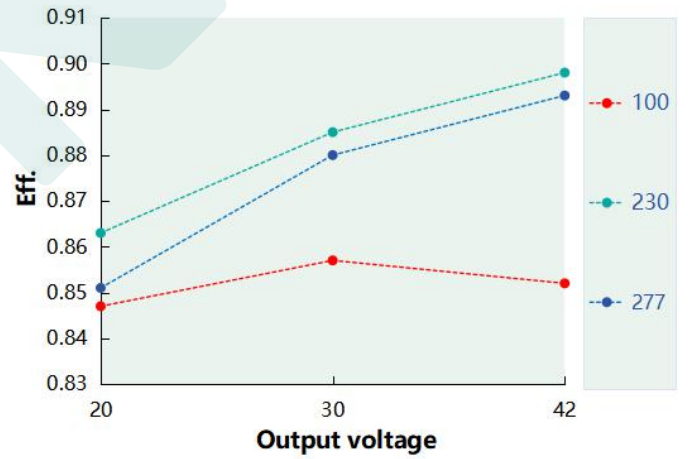

Eff. VS Output voltage(DL-30Z-AC900-MAC)

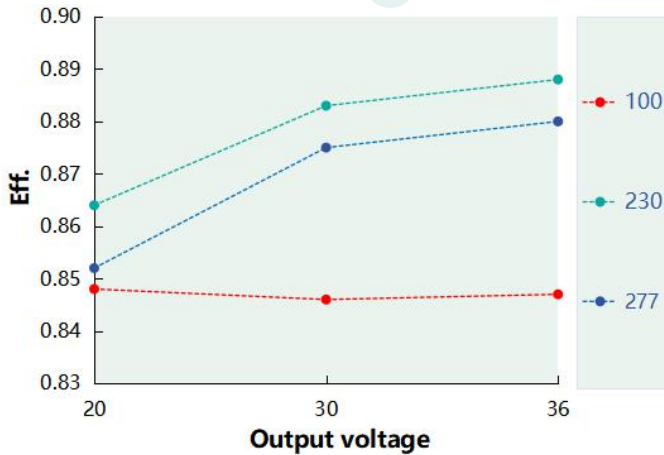

Power factor VS Input voltage(DL-30Z-AC600-MAC)

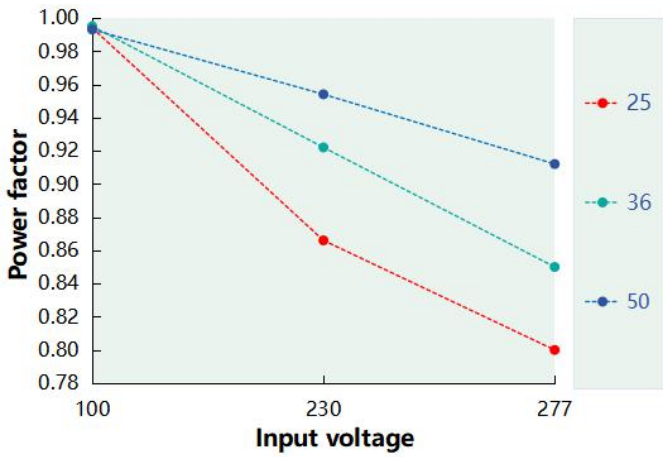

Power factor VS Input voltage(DL-30Z-AC750-MAC)

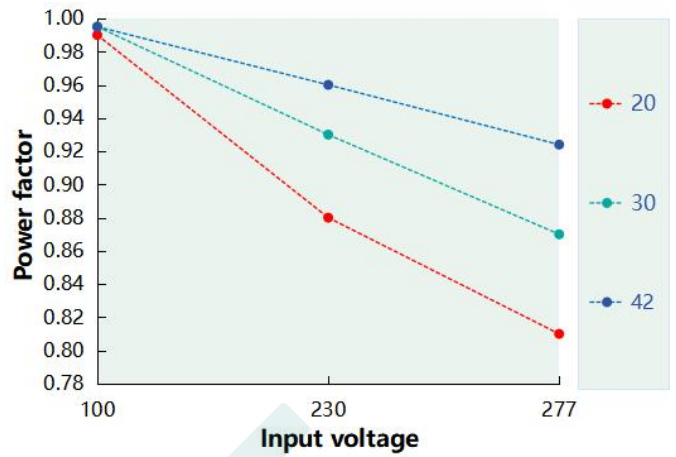

Power factor VS Input voltage(DL-30Z-AC900-MAC)

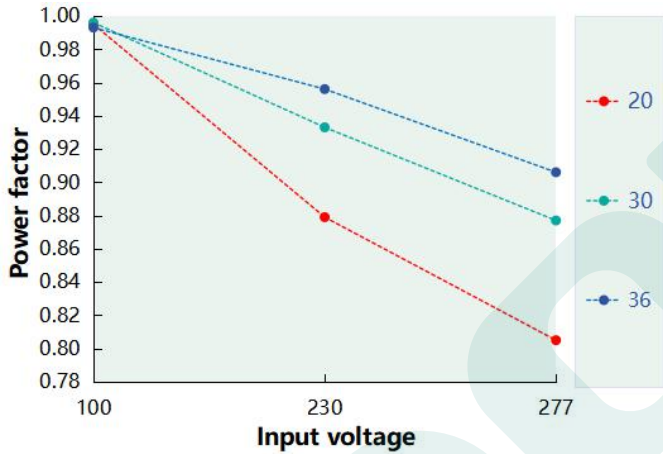

T.H.D. VS Output voltage(DL-30Z-AC600-MAC)

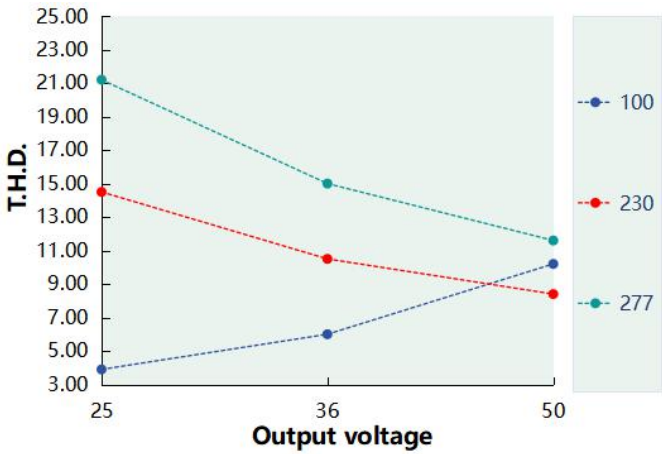

T.H.D. VS Output voltage(DL-30Z-AC750-MAC)

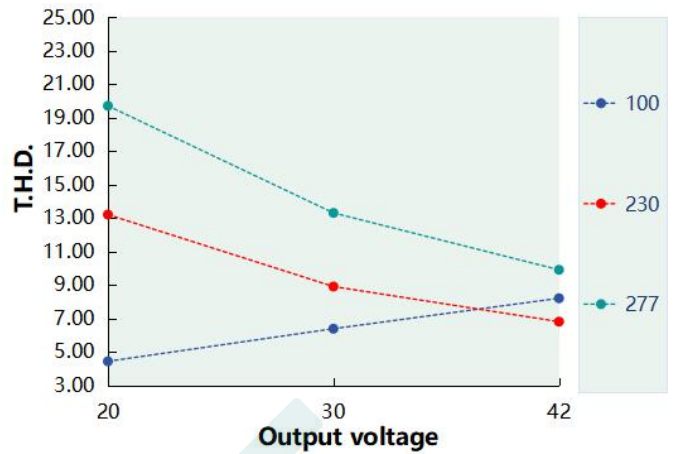

T.H.D. VS Output voltage(DL-30Z-AC900-MAC)

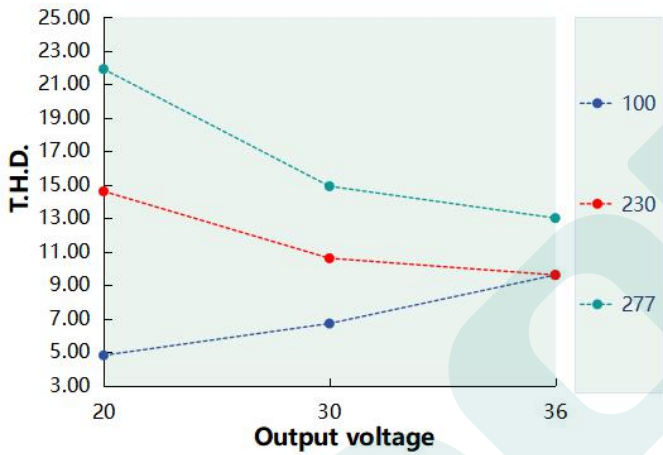

Tcase VS Lifetime (DL-30Z-AC-MAC)

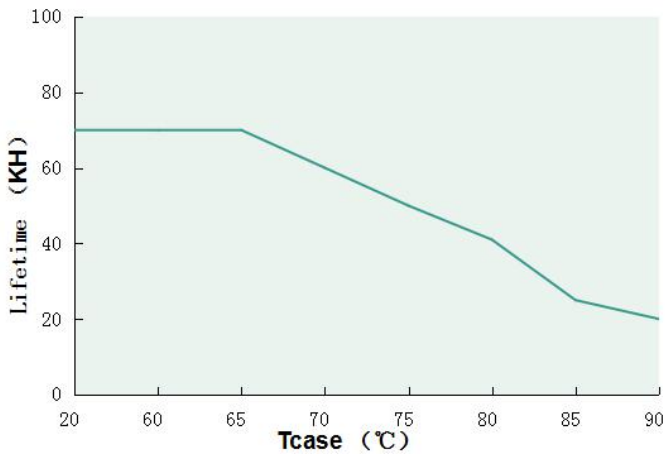

Output power VS Tcase (DL-30Z-AC-MAC)

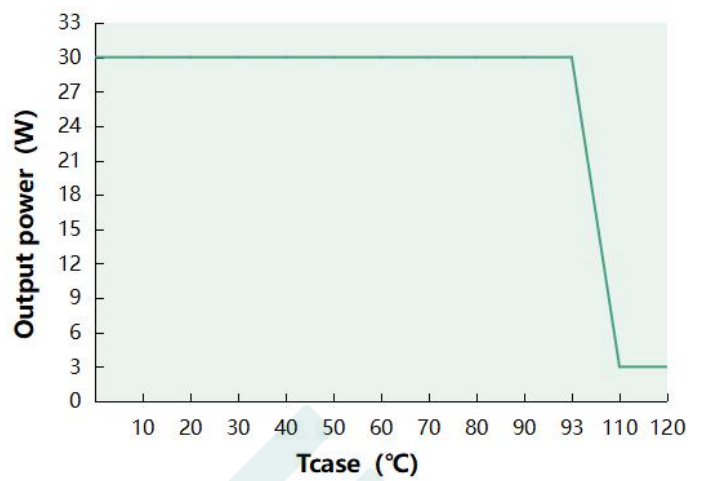

Inrush current(DL-30Z-AC-MAC)

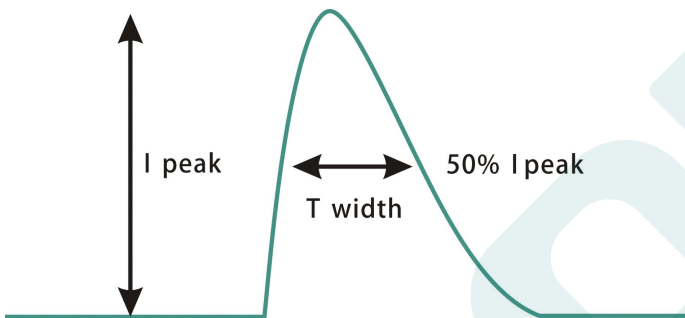

Input voltage	Peak current	T(@50% Peak current)
100Vac	16.8A	56.5us
230Vac	42.5A	137us
277Vac	53.3A	109us

Mechanical specification

Size (mm) L76*W64*H32

DL-30Z-AC-MAC

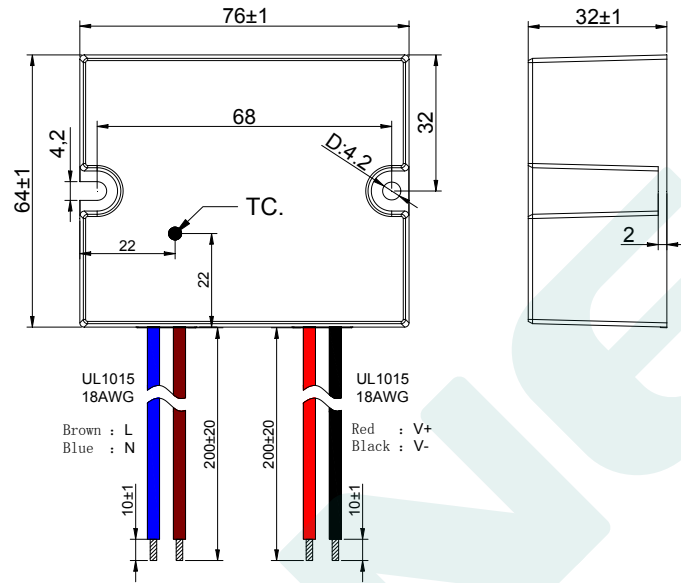

Weight

Weight 175 g

Packaging

Packaging (mm) L 475*W350*H160

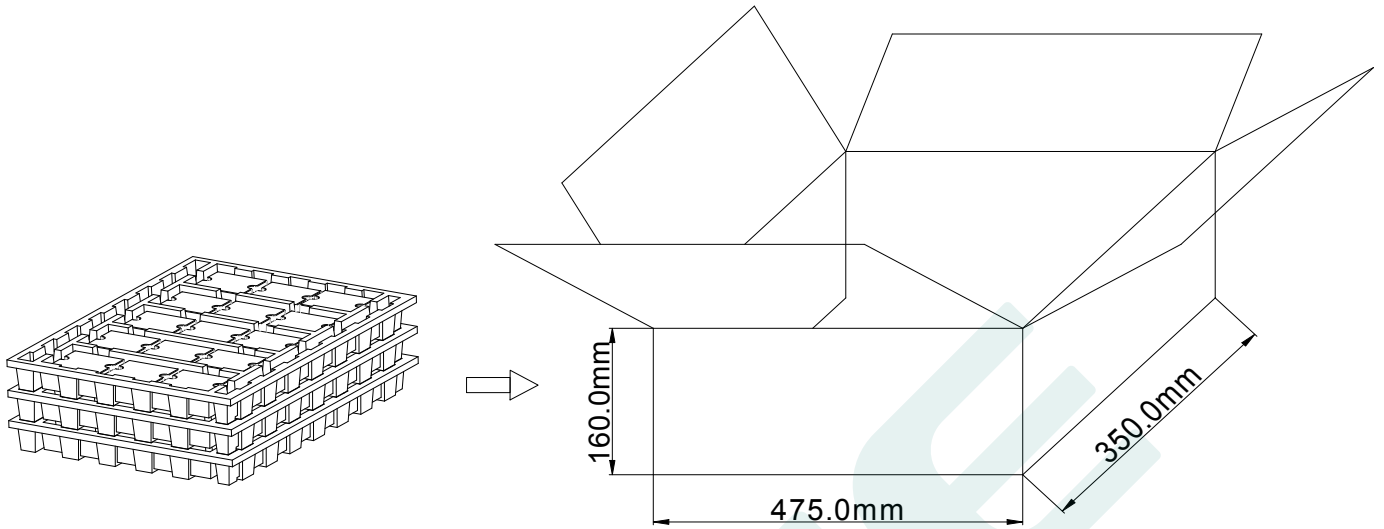

Note: One Carton 3 layers and 15 pcs each layer, total 45 pcs/carton.

Note:

1. According to the certificate obtained by the LED DRIVER, the LED DRIVER with the English label is sold in Europe, America and India.
2. The LED DRIVER with Chinese label is only used for China market.

Version

DATE	DESCRIPTION	REV.	CHECK
2024.11.15	Initial version.	V1.0	
2025.1.13	Modify PF	V1.1	
2025.6.14	Protection grade change to IP67	V1.2	

MANUFACTURER

EDIT	CHECK	APPROVE