

The logo for DONE, featuring the word "DONE" in a bold, teal, sans-serif font. The letter "D" is stylized with a white circular element on its left side. The logo is contained within a white rounded rectangle with a thin teal border.

DONE

MAC SERIES LED DRIVERS

DL-50Z-MAC SPEC V1.4

Features

- Class II structure
- Input voltage: 100-277 V ~ 50/60 Hz
- Efficiency : 89%(Typ.)
- constant current output control mode
- plastic shell structure, protection grade: IP67
- Lightning protection level: differential mode 6kV
- Function selection:
 The output current is fixed and unadjustable
- Lifetime design: 5 years



Applications

Road lighting, Industrial lighting, Venue lighting
 Floodlight lighting, Landscape lighting, Plant lighting



Model list

Model NO.	Input voltage	Output power	Output voltage	The default current	Eff.	T.H.D	PF
DL-50Z-C900-MAC	AC 100-277V 50/60Hz	50.4W	25-56Vdc	0.9A	≥89%	≤10%	≥0.95
DL-50Z-C1050-MAC	AC 100-277V 50/60Hz	52.5W	25-50Vdc	1.05A	≥89%	≤10%	≥0.95
DL-50Z-C1200-MAC	AC 100-277V 50/60Hz	45.6W	20-38Vdc	1.2A	≥88%	≤10%	≥0.95
DL-50Z-C1350-MAC	AC 100-277V 50/60Hz	51.3W	20-38Vdc	1.35A	≥88%	≤10%	≥0.95
DL-50Z-C1500-MAC	AC 100-277V 50/60Hz	54W	20-36Vdc	1.5A	≥88%	≤10%	≥0.95

Note: Test conditions of the above parameters: Ta=25°C, 230Vac input, full load operation for 30 minutes.

Input characteristics

Parameter	Min	Typ.	Max	Note
Rated input voltage	100Vac	230Vac	277Vac	
Input voltage range	95Vac		300Vac	
Rated frequency	47Hz	50/60Hz	63Hz	
Power factor	0.95	-	-	@230Vac full load, rated input voltage
T.H.D.	-	-	10%	@230Vac full load
Input current	-	-	0.7A	@100Vac full load
Inrush current	-	-	70A	230Vac, cold start (25°C)

Output characteristic

Parameter	Min	Typ.	Max	Note
Rated current				
DL-50Z-C900-MAC	-	0.9A	-	
DL-50Z-C1050-MAC	-	1.05A	-	
DL-50Z-C1200-MAC	-	1.2A	-	
DL-50Z-C1350-MAC	-	1.35A	-	
DL-50Z-C1500-MAC	-	1.5A	-	
Output voltage range				
DL-50Z-C900-MAC	25V	-	56V	
DL-50Z-C1050-MAC	25V	-	50V	
DL-50Z-C1200-MAC	20V	-	38V	
DL-50Z-C1350-MAC	20V	-	38V	
DL-50Z-C1500-MAC	20V	-	36V	
No-load voltage				
DL-50Z-C900-MAC	-	-	75V	
DL-50Z-C1050-MAC	-	-	69V	
DL-50Z-C1200-MAC	-	-	57V	
DL-50Z-C1350-MAC	-	-	57V	
DL-50Z-C1500-MAC	-	-	55V	
Efficiency@100Vac				
DL-50Z-C900-MAC	86%	87%	-	full load@100Vac
DL-50Z-C1050-MAC	86%	87%	-	
DL-50Z-C1200-MAC	84%	85%	-	
DL-50Z-C1350-MAC	84%	85%	-	
DL-50Z-C1500-MAC	84%	85%	-	

Output characteristic

Parameter	Min	Typ.	Max	Note
Efficiency@230Vac				
DL-50Z-C900-MAC	89%	90%	-	full load@230Vac
DL-50Z-C1050-MAC	89%	90%	-	
DL-50Z-C1200-MAC	87.7%	88.7%	-	
DL-50Z-C1350-MAC	87.7%	88.7%	-	
DL-50Z-C1500-MAC	87.7%	88.7%	-	
Accuracy of output current	-5%	-	+5%	full load@100-277Vac
Line regulation	-5%	-	+5%	@100-277Vac
Load regulation	-5%	-	+5%	@100-277Vac
Starting time	300 ms	-	1000 ms	Full load@100-277Vac

Note: Input voltage 95-100Vac, current accuracy, linear adjustment rate, load adjustment rate $\pm 7\%$.

Protection

Function		Function instructions			
Input over-voltage protection	Input over-voltage protection	Min.	Typ.	Max.	Notes
		305 Vac	320 Vac	350 Vac	Turn off the output when the input voltage exceeds protection voltage.
	Input over-voltage recovery	Min.	Typ.	Max.	Notes
		300 Vac	310 Vac	320 Vac	The driver will restart automatically when the input voltage falls below recovery voltage.
Output overload protection		Protection mode:hiccup mode,recovers automatically after fault condition is removed.			
Output short circuit protection		Hiccup mode:recovers automatically after fault condition is removed			
Over temperature protection		Self-recovery type :when the housing temperature is greater than 90°C, the output power decreases gradually.			
Output over-voltage protection		Protection mode: Hiccup mode or clamped in output highest voltage , the product is not damaged , LED driver works normally after fault condition is removed.			

Note:

1. Unless otherwise specified, all specifications and parameters shall be measured at the conditions of 230Vac (50Hz), rated load and 25°C of ambient temperature.
2. Including setting error, line regulation and load regulation.

Environmental

Environmental categories	Parameter
Working temperature	-40 ~ +55°C@200-277Vac, -40 ~ +45°C @100-200Vac (refer to "Life Curve ")
Max.Case Temp.	-40 ~ 90°C
Working humidity	20 ~ 95% RH, non condensing
Storage temperature、 humidity	-40 ~ +80°C, 10 ~ 95% RH
Resistant to vibration	10 ~ 500Hz, 5G 12 min/cycle, X, Y, Z axis 72 min each
MTBF	230Khrs min. MIL-HDBK-217F (Ta=25°C)
Lifetime	50000 hours @Tcase≤75°C, 230Vac, 80% Load, please refer to "Tcase VS Lifetime" section

Safety and EMC

Safety categories	Standard
Safety	GB19510.1、GB19510.14、EN61347-1、EN61347-2-13、IEC61347-1、IEC61347-2-13、AS/NZS61347.1、AS61347.2.13、EN 62384、UL8750
EMC	EN 55015、EN 61000-3-2 、GB/T 17743、GB17625.1、EN 61000-3-3
Surge protection	Differential mode L-N ±6KV (2 ohm) , refer to IEC61000-4-5 2014 Criterion B
High-pot test	I/P-O/P:3.75KVac
Insulation impedance	I/P-O/P:100MΩ / 500VDC / 25°C/ 70% RH
Leakage current	<0.7mA@277Vac

Note: The driver is considered as a component that will be operated in combination with the final equipment. Since EMC performance will be affected by the complete installation,the final equipment manufacturers must re-qualify EMC Directive on the complete installation again.

Eff. VS Output voltage(DL-50Z-C900-MAC)

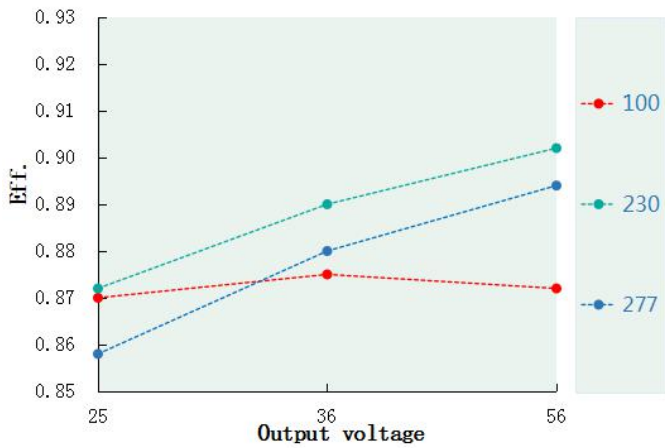

Eff. VS Output voltage(DL-50Z-C1050-MAC)

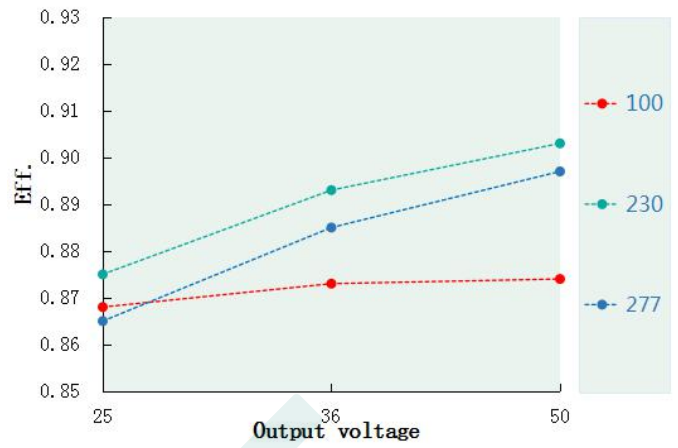

Eff. VS Output voltage(DL-50Z-C1200-MAC)

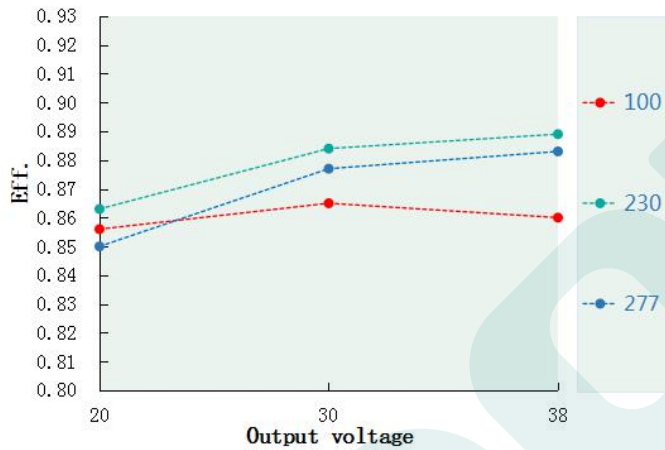

Eff. VS Output voltage(DL-50Z-C1350-MAC)

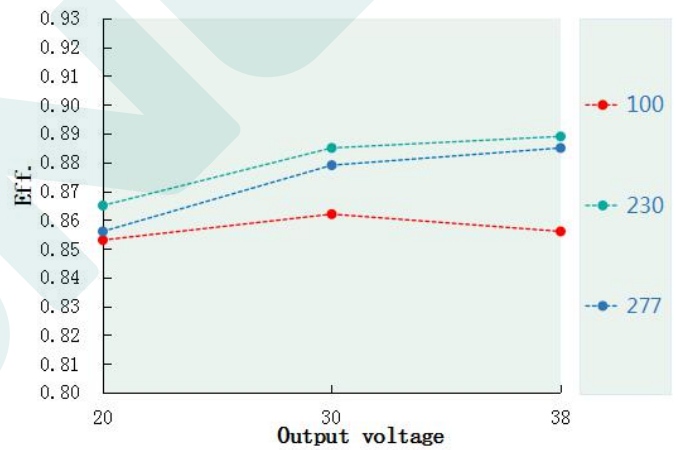

Eff. VS Output voltage(DL-50Z-C1500-MAC)

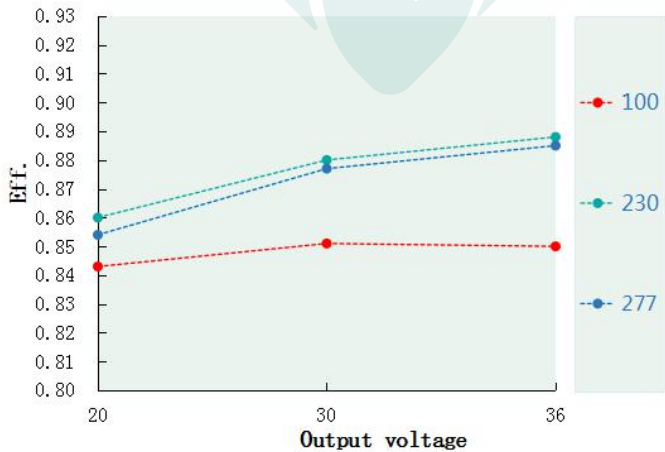

Power factor VS Input voltage(DL-50Z-C900-MAC)

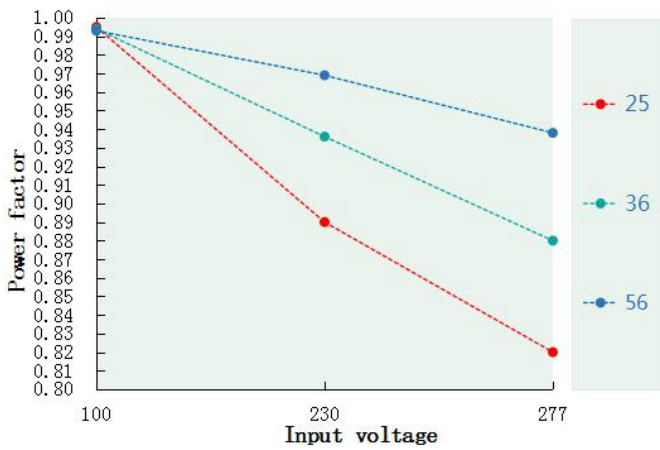

Power factor VS Input voltage(DL-50Z-C1050-MAC)

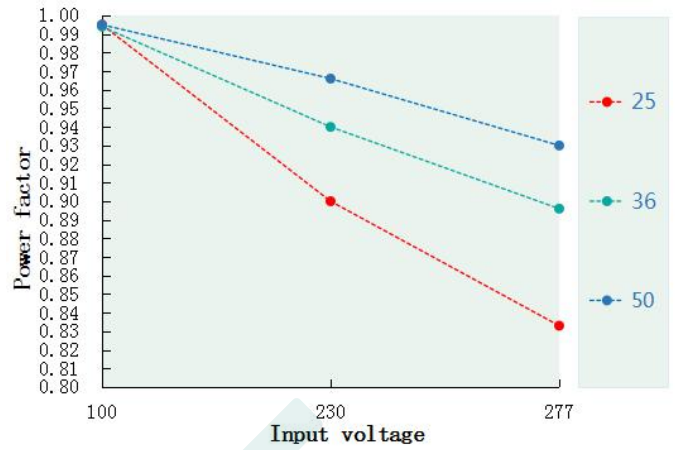

Power factor VS Input voltage(DL-50Z-C1200-MAC)

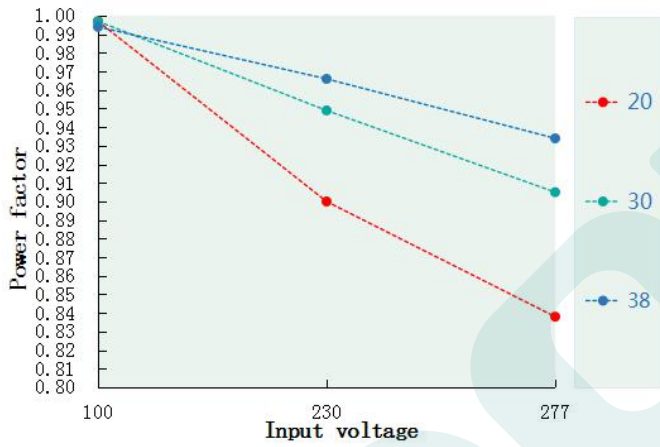

Power factor VS Input voltage(DL-50Z-C1350-MAC)

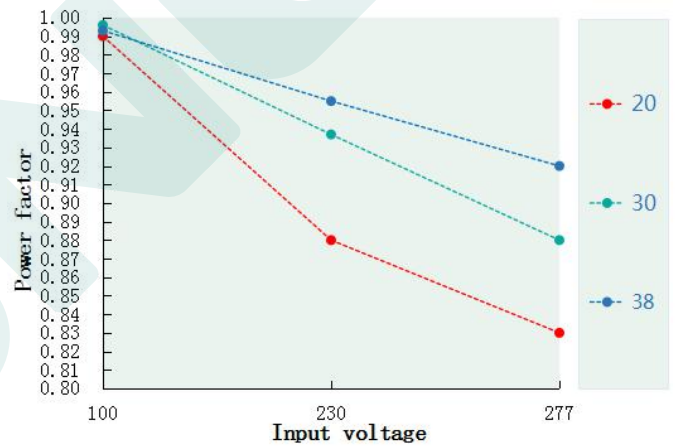

Power factor VS Input voltage(DL-50Z-C1500-MAC)

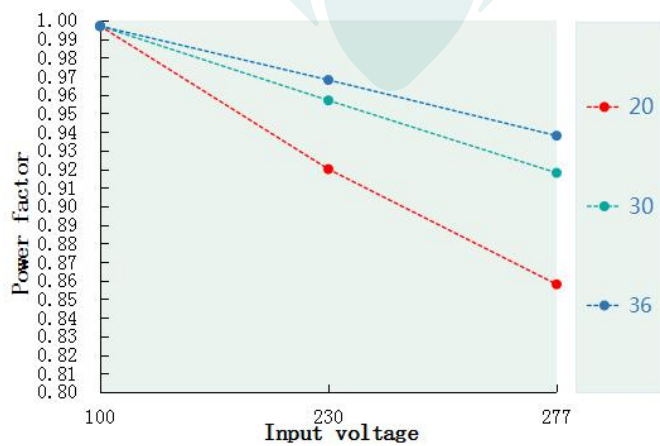

T.H.D. VS Output voltage(DL-50Z-C900-MAC)

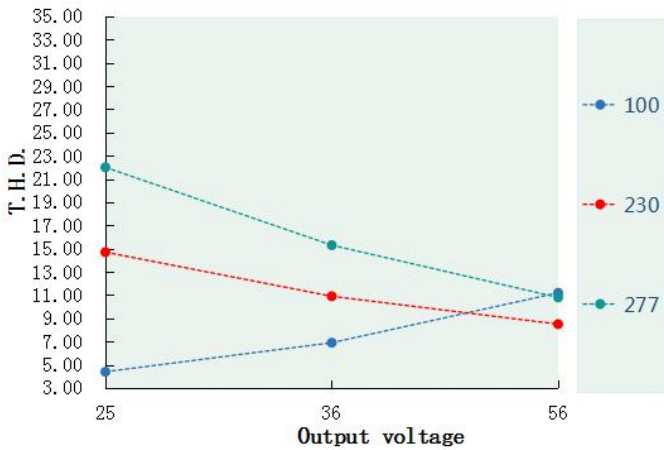

T.H.D. VS Output voltage(DL-50Z-C1050-MAC)

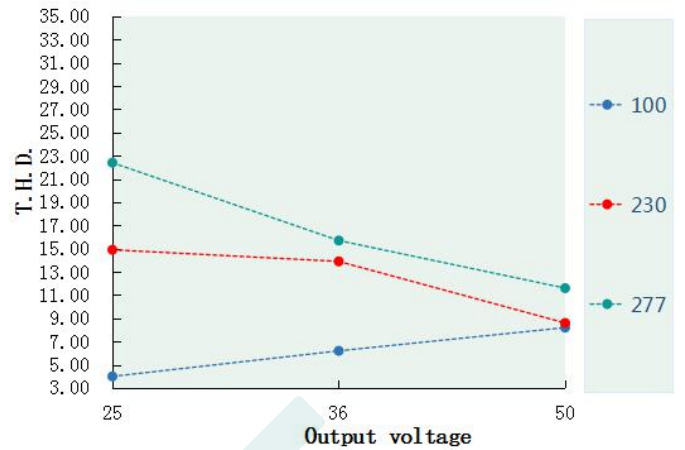

T.H.D. VS Output voltage(DL-50Z-C1200-MAC)

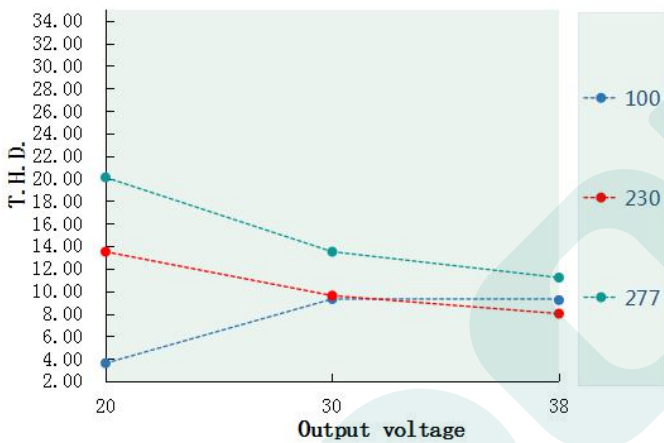

T.H.D. VS Output voltage(DL-50Z-C1350-MAC)

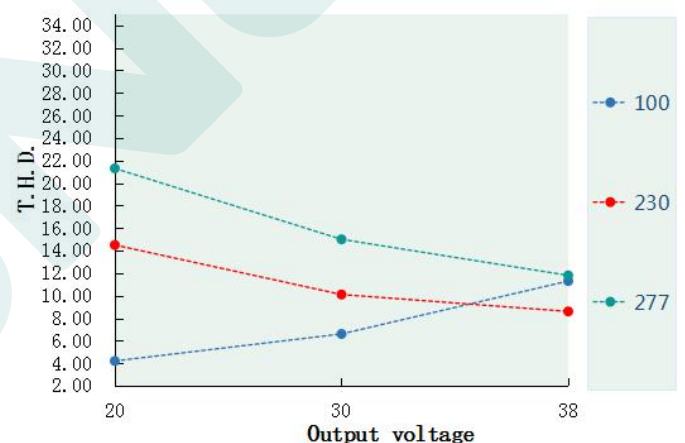

T.H.D. VS Output voltage(DL-50Z-C1500-MAC)

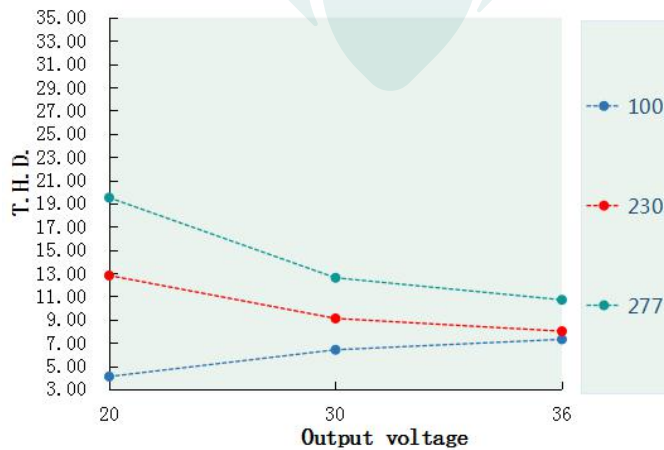

Tcase VS Lifetime (DL-50Z-MAC)

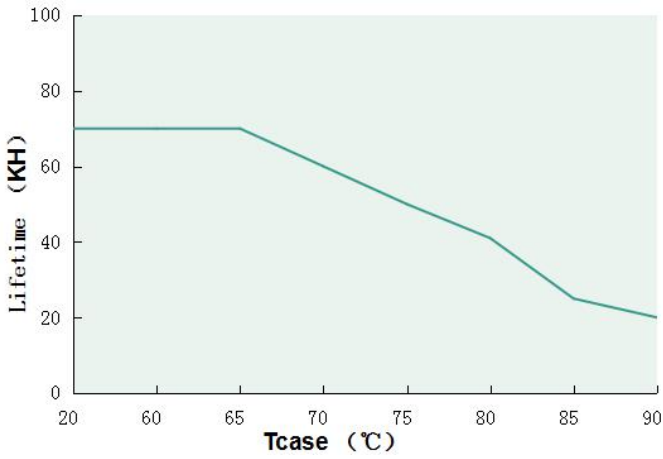

Output power VS Tcase (DL-50Z-MAC)

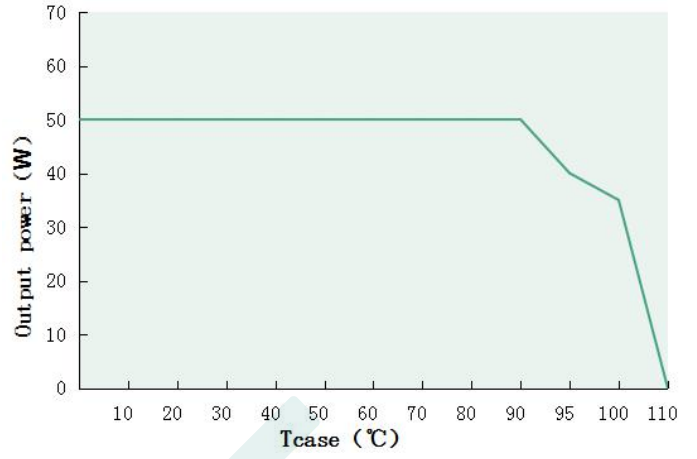

Inrush current(DL-50Z-MAC)

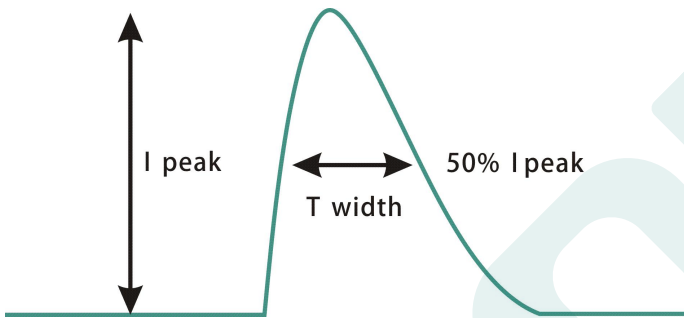

Input voltage	Peak current	T(@50% Peak current)
100Vac	16.8A	42us
230Vac	39A	67us
277Vac	40A	72us

Mechanical specification

Size (mm) L108*W35*H26

DL-50Z-MAC

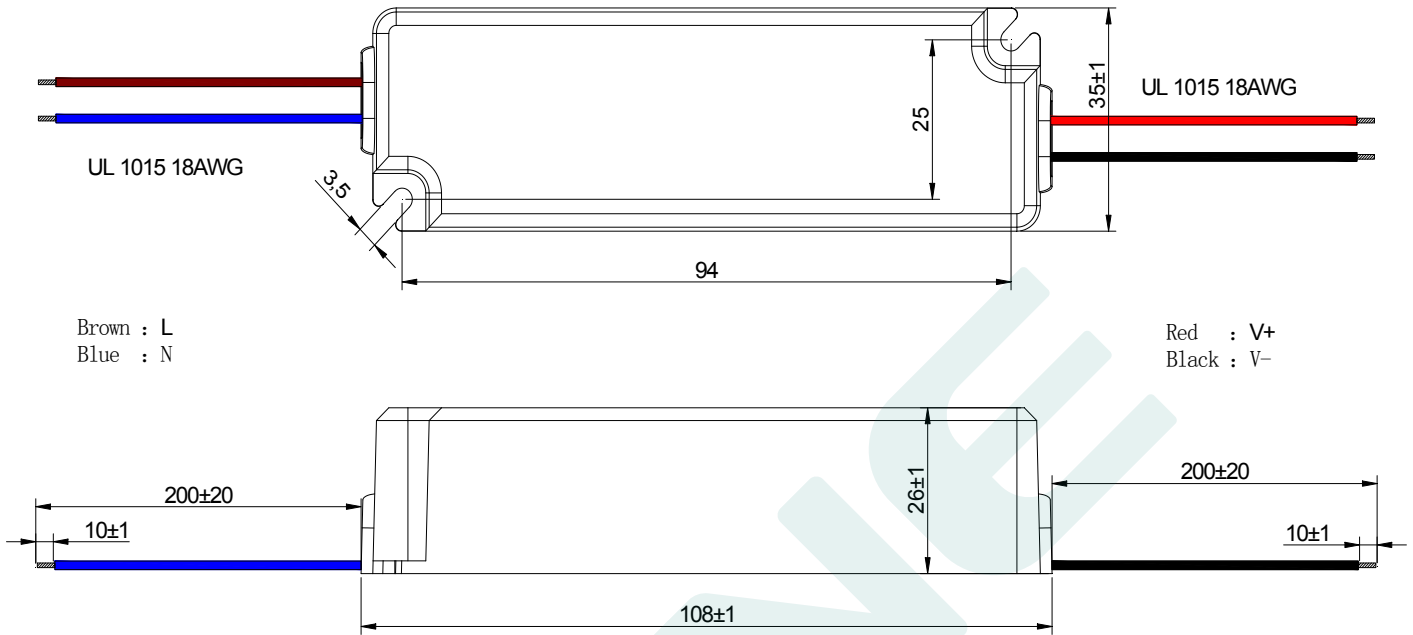

Weight

Weight 175 g

Packaging

Packaging (mm) L475*W350*H205

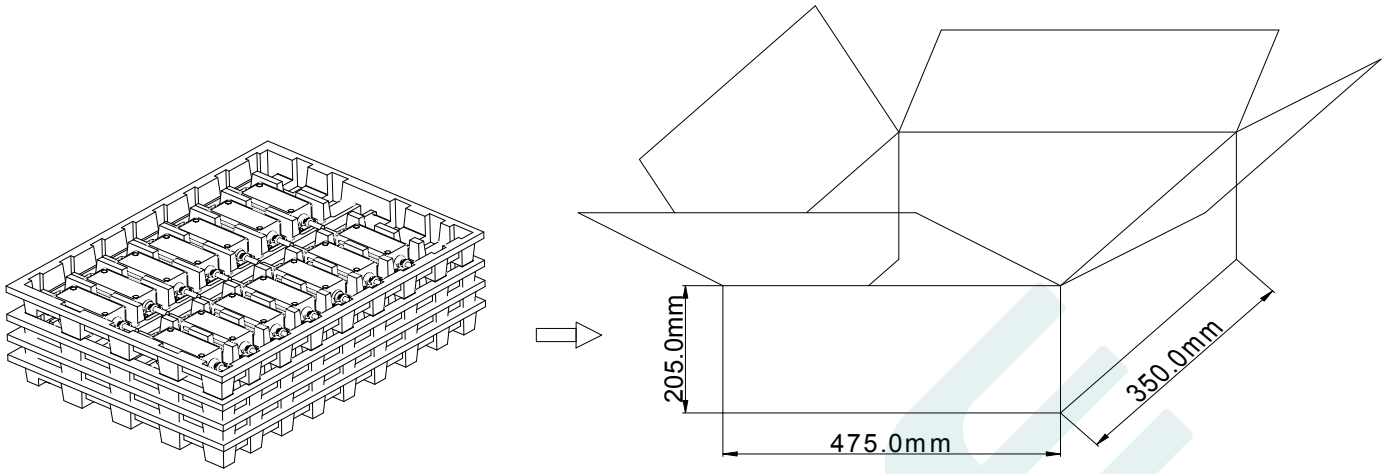

Note: One Carton 4 layers and 16 pcs each layer, total 64pcs/carton.

Note:

1. According to the certificate obtained by the LED DRIVER, the LED DRIVER with the English label is sold in Europe, America and India.
2. The LED DRIVER with Chinese label is only used for China market.

Version

DATE	DESCRIPTION	REV.	CHECK
2024.1.13	Initial version.	V1.0	
2024.5.4	Modify structure type.	V1.1	
2024.5.30	Modify the warranty period.	V1.2	
2024.9.18	Modify the no-load voltage, insulation impedance,output power and modify the safety certification icon.	V1.3	
2025.6.16	Protection grade change to IP67	V1.4	

MANUFACTRUER

EDIT

CHECK

APPROVE