

SOT-23 贴片塑封稳压二极管
SOT-23 Plastic-Encapsulate Zener Diode

SOT-23

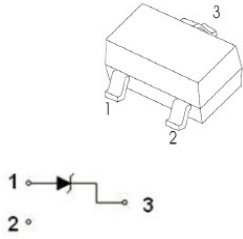

特征 Features

- 齐纳击穿阻抗低; Low Zener Impedance
- 最大功率耗散 300mW; Power Dissipation of 300mW
- 高稳定性和可靠性。High Stability and High Reliability

机械数据 Mechanical Data

- 封装: SOT-23 封装 SOT-23 Small Outline Plastic Package
- 环氧树脂 UL 易燃等级 Epoxy UL: 94V-0
- 安装位置: 任意 Mounting Position: Any

极限值和温度特性(TA = 25°C 除非另有规定)

Maximum Ratings & Thermal Characteristics (Ratings at 25°C ambient temperature unless otherwise specified.)

参数 Parameters	符号 Symbol	数值 Value	单位 Unit
功率消耗 Power Dissipation.(Note 1)	Pd	300	mW
正向压降 Forward Voltage @IF=10mA.(Note 2)	Vf	0.9	V
存储温度 Storage temperature range	Ts	-65-+150	°C
Thermal resistance junction to ambient air Warmewider stand Sperschicht –umgebende Luft	RthA	417	K/W

NOTES: 1) Valid provided that device terminals are kept at ambient temperature.

2) Test with pulse, period=5ms, pulse width=300us. 3) f=1KHz

电特性 (TA = 25°C 除非另有规定)

Electrical Characteristics (Ratings at 25°C ambient temperature unless otherwise specified).

Device	Marking	Zener Voltage Range Vz			Maximum Zener Impedance			Reverse Current Ir		Temperature Coefficient of Zener voltage @Izt=5mA mV/°C	
		Min	Max	Izt	Max	Max	Izk	Max	VR	Min	Max
		(V)	(V)	mA	Ω	Ω	mA	uA	V		
BZX84C 2V4	Z11	2.20	2.60	5	100	600	1.0	50.0	1.0	-3.5	0.0
BZX84C 2V7	Z12	2.50	2.90	5	100	600	1.0	20.0	1.0	-3.5	0.0
BZX84C 3V0	Z13	2.80	3.20	5	95	600	1.0	10.0	1.0	-3.5	0.0
BZX84C 3V3	Z14	3.10	3.50	5	95	600	1.0	5.0	1.0	-3.5	0.0
BZX84C 3V6	Z15	3.40	3.80	5	90	600	1.0	5.0	1.0	-3.5	0.0
BZX84C 3V9	Z16	3.70	4.10	5	90	600	1.0	3.0	1.0	-3.5	0.0
BZX84C 4V3	Z17	4.00	4.60	5	90	600	1.0	3.0	1.0	-3.5	0.0
BZX84C 4V7	Z1	4.40	5.00	5	80	500	1.0	3.0	2.0	-3.5	0.2
BZX84C 5V1	Z2	4.80	5.40	5	60	480	1.0	2.0	2.0	-2.7	1.2
BZX84C 5V6	Z3	5.20	6.00	5	40	400	1.0	1.0	2.0	-2.0	2.5
BZX84C 6V2	Z4	5.80	6.60	5	10	150	1.0	3.0	4.0	0.4	3.7
BZX84C 6V8	Z5	6.40	7.20	5	15	80	1.0	2.0	4.0	1.2	4.5
BZX84C 7V5	Z6	7.00	7.90	5	15	80	1.0	1.0	5.0	2.5	5.3
BZX84C 8V2	Z7	7.70	8.70	5	15	80	1.0	0.7	5.0	3.2	6.2
BZX84C 9V1	Z8	8.50	9.60	5	15	100	1.0	0.5	6.0	3.8	7.0
BZX84C 10	Z9	9.40	10.60	5	20	150	1.0	0.2	7.0	4.5	8.0
BZX84C 11	Y1•	10.40	11.60	5	20	150	1.0	0.1	8.0	5.4	9.0
BZX84C 12	Y2•	11.40	12.70	5	25	150	1.0	0.1	8.0	6.0	10.0
BZX84C 13	Y3	12.40	14.10	5	30	170	1.0	0.1	8.0	7.0	11.0
BZX84C 15	Y4	13.80	15.60	5	30	200	1.0	0.1	10.5	9.2	13.0
BZX84C 16	Y5	15.30	17.10	5	40	200	1.0	0.1	11.2	10.4	14.0
BZX84C 18	Y6•	16.80	19.10	5	45	225	1.0	0.1	12.6	12.4	16.0
BZX84C 20	Y7	18.80	21.20	5	55	225	1.0	0.1	14.0	14.4	18.0
BZX84C 22	Y8	20.80	23.30	5	55	250	1.0	0.1	15.4	16.4	20.0
BZX84C 24	Y9	22.80	25.60	5	70	250	1.0	0.1	16.8	18.4	22.0
BZX84C 27	Y10	25.10	28.90	2	80	300	0.5	0.1	18.9	21.4	25.3
BZX84C 30	Y11•	28.00	32.00	2	80	300	0.5	0.1	21.0	24.4	29.4
BZX84C 33	Y12	31.00	35.00	2	80	325	0.5	0.1	23.1	27.1	33.4
BZX84C 36	Y13	34.00	38.00	2	90	350	0.5	0.1	25.2	30.4	37.4
BZX84C 39	Y14	37.00	41.00	2	130	350	0.5	0.1	27.3	33.4	41.2
BZX84C 43	Y15	40.00	46.00	2	100	700	1.0	0.1	32.0	10.0	12.0
BZX84C 47	Y16	44.00	50.00	2	100	750	1.0	0.1	35.0	10.0	12.0
BZX84C 51	Y17	48.00	54.00	2	125	750	1.0	0.1	38.0	10.0	12.0
BZX84C 56	Y18	52.00	60.00	2	135	700	1.0	0.1	39.0	10.0	12.0
BZX84C 62	Y19	58.00	66.00	2	200	1000	1.0	0.2	47.0	10.0	12.0
BZX84C 68	Y20	64.00	72.00	2	250	1000	1.0	0.2	52.0	10.0	12.0
BZX84C 75	Y21•	70.00	79.00	2	300	1000	1.0	0.2	57.0	10.0	12.0

Breakdown characteristics
at $T_j = \text{constant}$ (pulsed)

Zener Characteristics (V_z Up to 10 V)

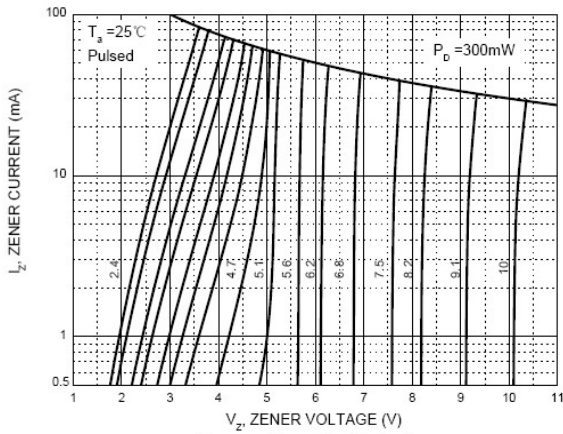

Zener Characteristics (11 V to 43 V)

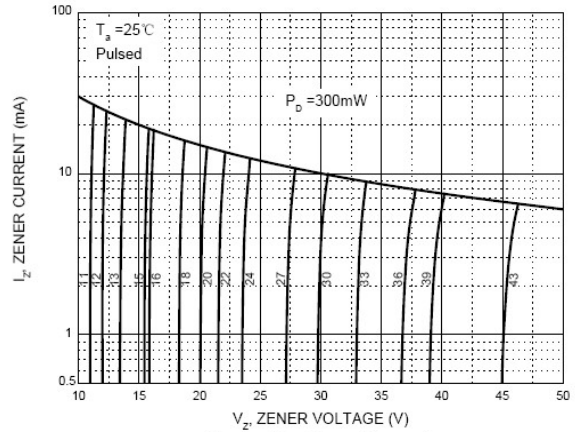

Temperature Coefficients

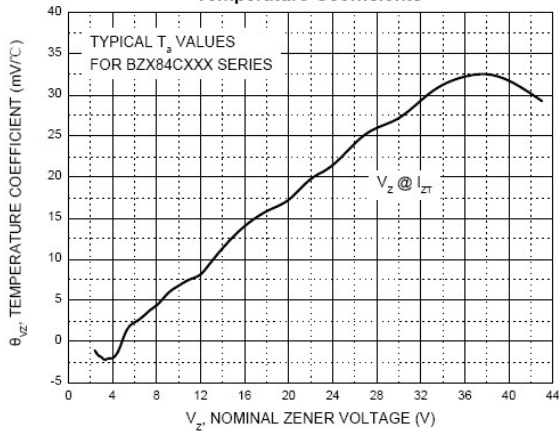

Typical Leakage Current

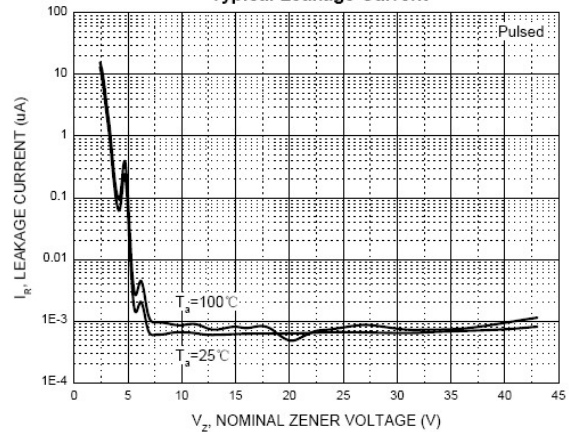

Typical Capacitance

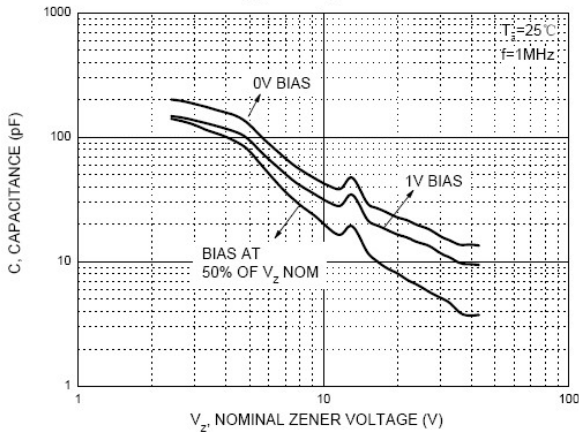

Effect of Zener Voltage on Zener Impedance

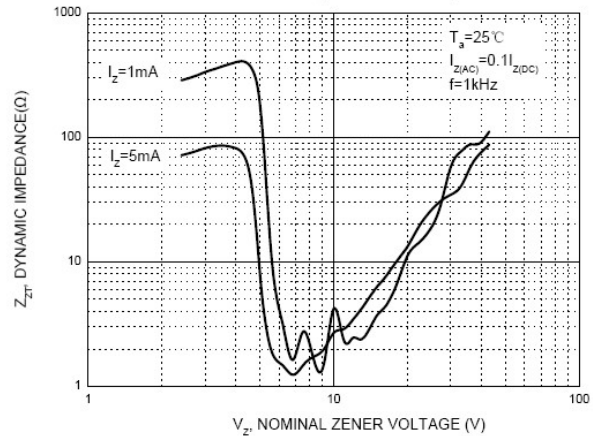

Power Derating Curve

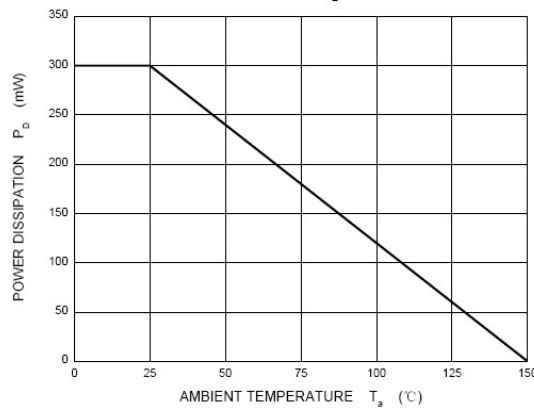

SOT-23 PACKAGE OUTLINE Plastic surface mounted package

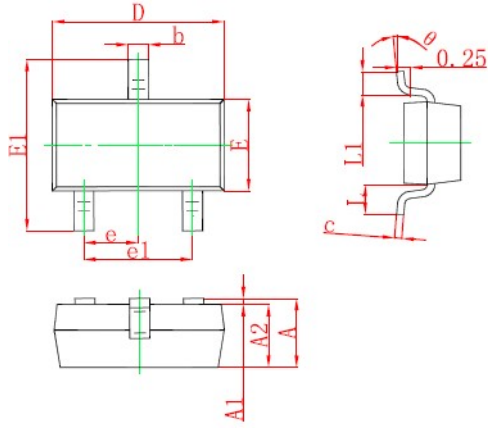

Symbol	Dimensions In Millimeters		Dimensions In Inches	
	Min	Max	Min	Max
A	0.900	1.150	0.035	0.045
A1	0.000	0.100	0.000	0.004
A2	0.900	1.050	0.035	0.041
b	0.300	0.500	0.012	0.020
c	0.080	0.150	0.003	0.006
D	2.800	3.000	0.110	0.118
E	1.200	1.400	0.047	0.055
E1	2.250	2.550	0.089	0.100
e	0.950 TYP		0.037 TYP	
e1	1.800	2.000	0.071	0.079
L	0.560 REF		0.022 REF	
L1	0.300	0.500	0.012	0.020
e	0°	8°	0°	8°

焊盘设计参考 Precautions: PCB Design

Recommended land dimensions for SOT-23 diode. Electrode patterns for PCBs

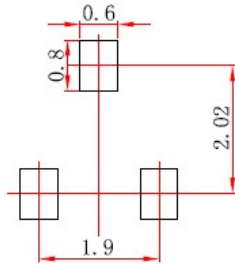

Note:

1. Controlling dimension: In millimeters.
2. General tolerance: ± 0.05mm.
3. The pad layout is for reference purposes only.